



SLV NUMINOS®

Ein Down- und Spotlightsystem.
Tausend Möglichkeiten.

immer
up to date !

laden Sie sich die aktuelle Preisliste unter

KS-Licht.ch/Preisliste_NUMINOS

herunter oder scannen Sie den QR-Code !



Unsere AGB für Geschäftskunden finden Sie [hier](#).



KS LICHT in Essen : seit 30 Jahren starke Partner in Sachen Licht

ABHOLZENTRUM IN ESSEN

Seit 30 Jahren ergänzt KS Licht- und Elektrotechnik GmbH die Produkte und Leistungen von über 220 TOP Beleuchtungsmarken mit einer Vielzahl von Serviceleistungen. Wir unterhalten für Sie ein Abholzentrum mitten im Herzen des Ruhrgebiets, in dem Sie die bei uns bestellte Ware kurzfristig abholen können.

SLV LEUCHTEN LIVE ERLEBEN

Auf mehr als 300 m² Ausstellungsfläche präsentieren wir Ihnen eine große Auswahl verschiedenster Leuchten. Hier beraten Sie unsere fachlich geschulten Berater und Lichtplaner persönlich. Gleichzeitig können Sie unsere Ausstellung nutzen, um Ihren Kunden unsere Leuchten in Funktion und Wirkung zu präsentieren. Überzeugen Sie sich von der Qualität unserer Außenleuchten in der Outdoor-Ausstellung.

KOSTENLOSE LICHTPLANUNG

Wir entwickeln mit Ihnen und nach Ihren Bedürfnissen praxisorientierte Lichtlösungen. Ob für Geschäftsräume, Verkaufsräume oder privates Ambiente: Unsere Lichtplaner haben immer die passenden Konzepte für eine bedarfsorientierte und energetisch sinnvolle Lösung parat. Gerne berechnen wir für Sie die Amortisationszeit Ihrer neuen, energiesparenden LED-Beleuchtung.

KS MULTI-BRAND LEUCHTEN ONLINESHOP

In unserem Business-Onlineshop unter www.KS-Licht.ch finden Sie alles, was Sie bei Ihrer täglichen Arbeit unterstützt:

- Aktuelle Sonderangebote und Neuheiten
- Onlineprüfung der Warenverfügbarkeit
- Alle Ersatzteile bequem finden und bestellen
- Schnellbestellformular
- Alle Kataloge zum Downloaden oder als Blätterkatalog mit Produktlinks
- Ausschreibungstexte, Lichtverteilungskurven/LDT Plugins und Schnellrechentabellen

KS Licht- u. Elektrotechnik GmbH
Manderscheidtstr. 8c
45141 Essen

Tel.: +49 (0)201-89924-0
Fax: +49 (0)201-89924-124

Onlineshop: www.KS-Licht.ch
Internet: www.KS-Germany.com
Email: Verkauf@KS-Germany.com

Besuchen Sie uns vor Ort oder rufen Sie uns an:
Montag - Donnerstag durchgehend von 08.00 Uhr bis 16.30 Uhr
Freitag durchgehend von 08.00 Uhr bis 15.00 Uhr

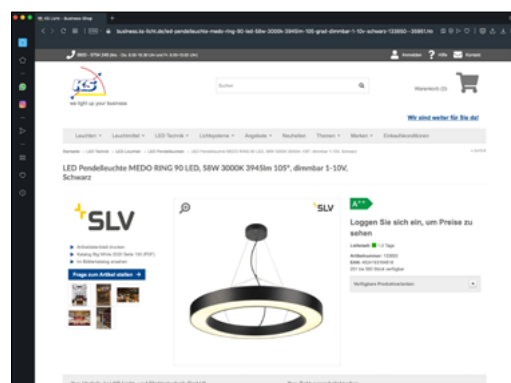
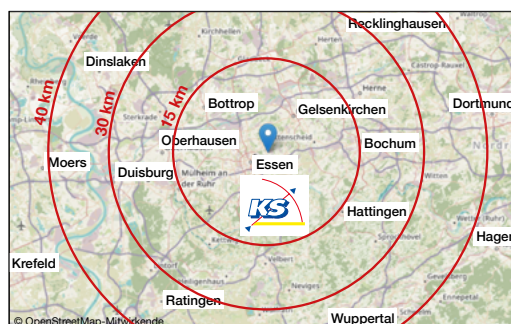

Scannen Sie den Link zu unserem Schnellbestellformular und erhalten Sie aktuelle Informationen über die Warenverfügbarkeit!



www.KS-Licht.ch/schnellbestellformular





SLV NUMINOS®
DOWN- UND
SPOTLIGHTS

Das SLV NUMINOS® Leuchtensystem bietet konstante Lichteigenschaften und modernes Design über alle Anwendungen hinweg. Lassen Sie sich inspirieren.





FÜR JEDEN FALL
DIE PASSENDE
LICHTLÖSUNG.



SLV NUMINOS®

Ein Leuchtensystem – Tausend Möglichkeiten.

Das frei konfigurierbare Leuchtensystem,
das jedes Ambiente ins beste Licht rückt.

Kein Projekt ist wie das andere. Aber viele Projekte verlangen ein einheitliches Licht- und Designkonzept. SLV NUMINOS® ist ein perfekt aufeinander abgestimmtes Leuchtensystem, das Funktion, Design und Technik in Einklang bringt. Für Planer und Macher. Für jede Anforderung. Für maximale Vielfalt bei minimalem Aufwand.

NUMINOS®

HOCHLEISTUNGS LED MODUL MIT
BRILLANTER FARBWIEDERGABE



BREITE AUSWAHL AN DOWNLIGHTS
UND SPOTS FÜR EIN HARMONISCHES
DESIGNKONZEPT.



SLV NUMINOS®

MEHR FREIHEIT.

Mit System.

Was Sie auch vorhaben – das SLV NUMINOS® Leuchtensystem schafft Raum für Ideen.



Das SLV NUMINOS® Leuchtensystem bietet konstante Lichteigenschaften und modernes Design über alle Anwendungen hinweg:

- für Büroräume
- Shops & Boutiquen
- Hotellerie & Gastronomie
- Zuhause
- und vieles mehr

Vom Hotel übers Büro bis hin zu gewerblichen oder privaten Räumen. Von der Anwendung über die Technik bis zum Design im Detail: Gut, dass sich die modularen Down- und Spotlights genauso konfigurieren lassen, wie es die Planung oder Raumbedingungen erfordern. Und je facettenreicher Ihr Projekt ist, desto mehr profitieren Sie vom SLV NUMINOS® Leuchtensystem.

Licht inszenieren,
ohne zu dominieren.



SLV NUMINOS®
GIMBLE M, DL
Art.-Nr.
1005945
SLV NUMINOS®
Move S, DL
Art.-Nr.
1005340



Highlights,
die nach unten
strahlen.



SLV NUMINOS®
XL, CL
Art.-Nr.
1005767

Frei für alle
Dimensionen.



SLV NUMINOS®
Zoom M, 3Ph.
Art.-Nr.
1006116

Perfekt zum
Pendeln, in der
Höhe variabel.



SLV NUMINOS®
XL, PD
Art.-Nr.
1005783

EINZIGARTIGE VIELFALT,
GEMEINSAME HIGHLIGHTS.

Wählen Sie zwischen:

- Downlight oder Spotlight
- Größen und Durchmessern
- Gehäusefarben (Schwarz/Weiß)
- Reflektorvarianten
- Schwenkbaren und starren Versionen
- Leistungsklassen

Die verschiedenen Varianten verfügen über:

- Hochleistungs LED Modul mit den Lichtfarben 2700K/3000K/4000K
- Farbqualität CRI>90
- Blendungsbewertung UGR mind. <22

EIN LEUCHTENSYSTEM.

Durchdacht bis ins Detail.



DOWNLIGHTS

- In sieben Varianten (68-75mm bis 176-186mm) mit Hochleistungs-LED-Modul in drei Lichtfarben (2700K, 3000K, 4000K) und Blendungsbewertungen (UGR 16, 19, 22) erhältlich.
- Wählbare Reflektoren mit Halbstreuwinkeln von 20°, 40° oder 55°.
- Verschiedene Effektfilter (gefrostet/prismatisch/elliptisch/Wabe) als Zubehör verfügbar.
- Dekoring als sichtbarer Abschluss in Weiß, Schwarz oder Chrom wählbar.

SLV NUMINOS® Downlights sind als starre oder schwenkbare Variante (4x fix und 3x dreh- und schwenkbar) erhältlich.



XS **S** **M** **L** **XL**

Zubehör mit System:

Ihren optionalen Treiber (On/Off, Phasendimmung, DALI) und passende Diffusoren können Sie über die Farbkodierung ganz einfach hinzufügen.

Treiber, Diffusoren und Reduzierringe für das SLV NUMINOS® Downlight System finden Sie auf den Seiten 50-53.

Dank der breiten Auswahl an Modulen gibt es für jede Anforderung die passende Lösung. Fix konfiguriert. Schnell und sicher installiert.



SPOTLIGHTS

- In drei Gehäusegrößen (65x155mm, 85x175mm, 100x203mm) mit Hochleistungs LED Modul in drei Lichtfarben (2700K, 3000K, 4000K) verfügbar.
- Durch den verbauten LED-Treiber (Phasendimmung, DALI) sind alle Spotlights für den direkten Anschluss an 230V Netzspannung geeignet.
- Wählbare Linsen mit Halbstreuwinkeln von 24°, 36° oder 60°.

SLV NUMINOS® Spotlights sind als schwenkbarer oder starrer Deckenspot, Pendelleuchte und als Spot für 3-Phasen Schienensysteme erhältlich.



Easy to install.

Weil sich Effizienz immer auszahlt, sind SLV Leuchten leicht, schnell und sicher zu installieren. So bietet der Anschluss via Montageplatte, Schienensystem, Schnellkupplung, Federbügel oder mit farbkodierten Treibern für Downlights einen entscheidenden Vorteil: Sie sparen Zeit Aufwand und damit auch Kosten.

EIN LEUCHTENSYSYSTEM.

Für alle Fälle.

Für Erfolg unter allen Bedingungen braucht es Teamplayer, die mit individuellen Stärken glänzen. Entdecken Sie, für welche Einsätze sich SLV NUMINOS® Leuchten besonders gut eignen.



Objekte zu einem
Hingucker machen.



SLV NUMINOS®
GIMBLE XS, DL
Art.-Nr.
1005817

Downlights.

Unauffällige, moderne und platzsparende Beleuchtung, die den Fokus auf Objekte oder den Raum lenkt: Die Downlights des SLV NUMINOS® Leuchtensystems sind in in gewerblichen und privaten Räumen variabel einsetzbar.



Für die elegante
Ausleuchtung von
Wohnbereichen.



SLV NUMINOS®
GIMBLE XS, DL
Art.-Nr.
1005843

Für Eingangsbe-
reiche, die Gäste
willkommen heißen.



SLV NUMINOS®
XS, DL
Art.-Nr.
1005520



In Fluren den
Weg weisen.



SLV NUMINOS®
MOVE XS, DL
Art.-Nr.
1005584

Beleuchtung individuell gestalten.

Durch die große Auswahl an Reflektoren eignet sich das SLV NUMINOS® Leuchtensystem für die Akzentbeleuchtung wie auch zur Ausleuchtung von Produkten und Verkaufsflächen.

Um in Verkaufsräumen Akzente zu setzen.



SLV NUMINOS®
GIMBLE M, DL
Art.-Nr.
1005953



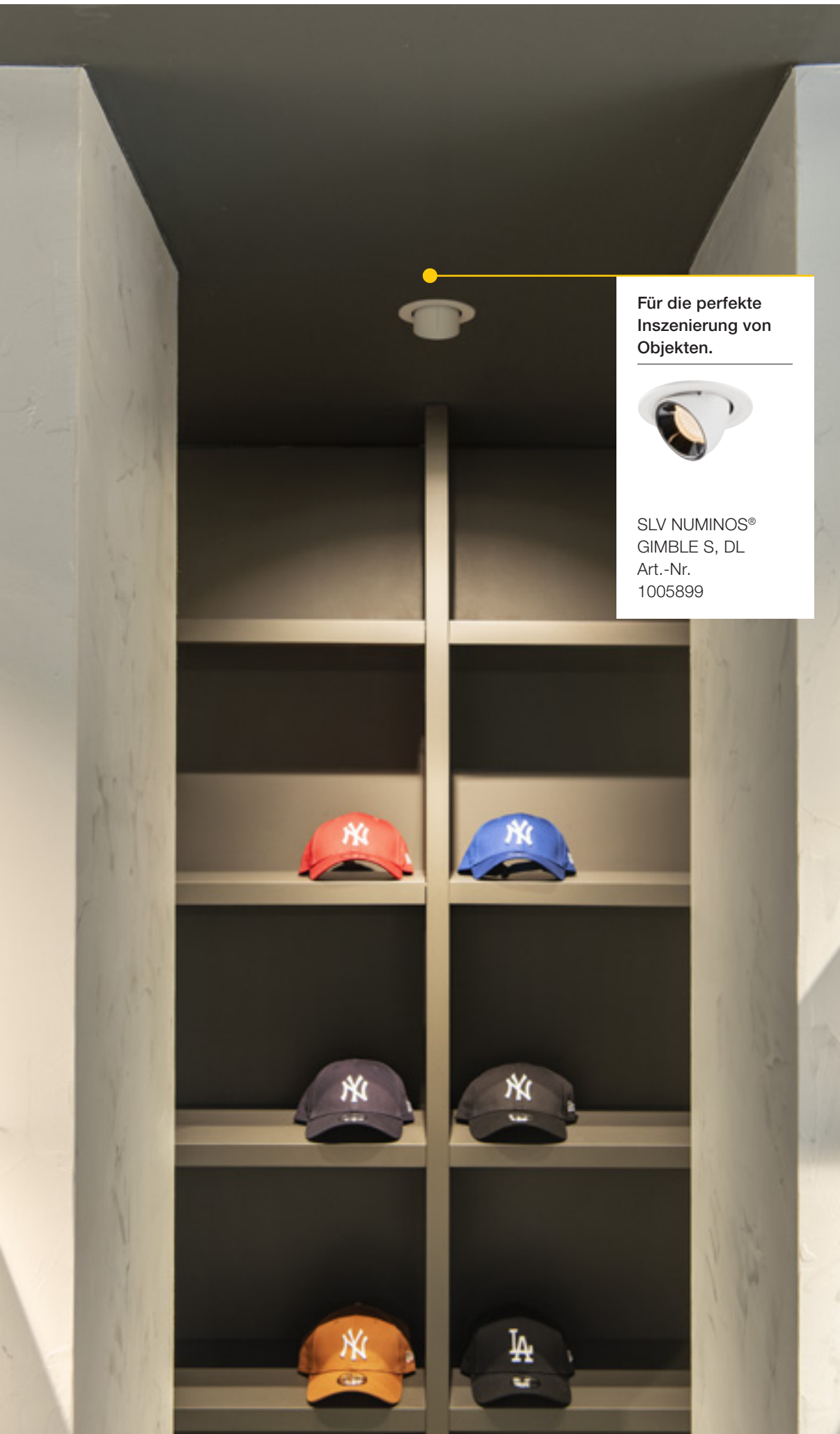

Für die perfekte
Inszenierung von
Objekten.



SLV NUMINOS®
GIMBLE S, DL
Art.-Nr.
1005899



Für eine flexible Ausleuchtung in alle Raumdimensionen.



SLV NUMINOS®
ZOOM M 3Ph.,
PHASE
Art.-Nr. 1006108

Produkte gekonnt in Szene setzen.



SLV NUMINOS®
ZOOM M
3Ph., DALI
Art.-Nr. 1006119

Spotlights.

In Shops und Boutiquen, aber auch in Restaurants, Bars, Museen, Studios, Praxen – in jedem Raum kommt es auf gekonnt gesetzte Akzente an. Spotlights sind sowohl für die Ausleuchtung größerer Flächen, als auch für die punktuelle Beleuchtung einsetzbar.





Um ein appetitanregendes Ambiente zu erschaffen.



SLV NUMINOS® M
PD, PHASE
Art.-Nr.
1004247
kombiniert
mit Zierring
Art.-Nr.
1006168

SLV NUMINOS®

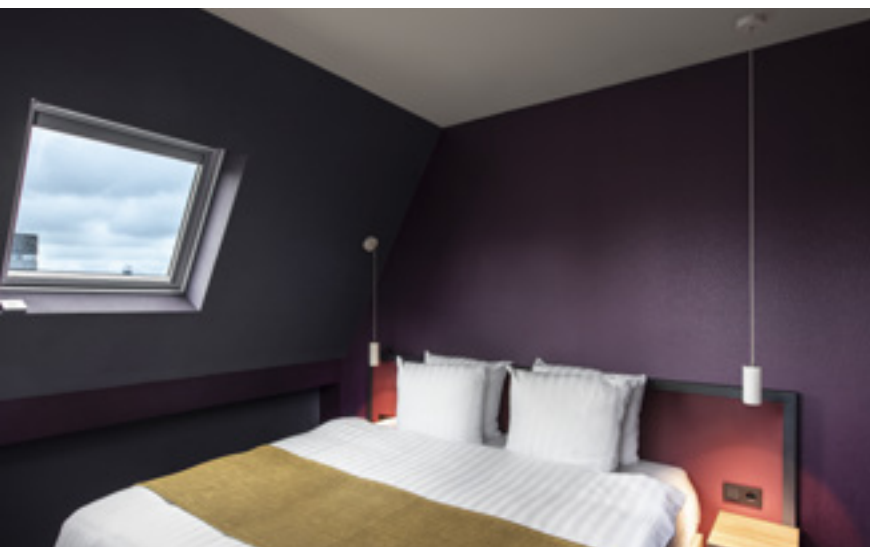

Für mehr Gemütlichkeit zu Hause.



SLV NUMINOS® S, PD, DALI
Art.-Nr. 1004439
kombiniert mit Zierring
Art.-Nr. 1006167



SYSTEMATISCH.

Zum Ziel.

Mit dem SLV NUMINOS® Online Konfigurator.

Nur drei Schritte und Sie sind am Ziel:

So einfach funktioniert der Konfigurator:

Die erste Frage lautet: Downlight oder Spotlight? Anschließend wählen Sie zwischen vorkonfigurierten und weiter anpassbaren Anwendungsszenarien oder der freien Konfiguration.

Falls Sie bei der Auswahl der Attribute noch unsicher sind, kein Problem: Zu jeder gewählten Konfiguration bieten wir Ihnen passende Erklärungen an.

Hier gelangen Sie zum SLV NUMINOS® Konfigurator:

[KS-Licht.ch/NUMINOS-Konfiguratoren](https://www.ksl.ch/NUMINOS-Konfiguratoren)

1 TECHNISCHE KONFIGURATION



2 OPTISCHE KONFIGURATION



3 VISUELLE DARSTELLUNG & ABSCHLUSS



Hier und jetzt zum Ziel – konfigurieren Sie Ihre Leuchte mit dem BIG WHITE®.

Stellen Sie Ihre Wunschleuchten auf den nächsten Seiten zusammen.

Die folgenden Produktübersichten bringen Sie ebenso leicht zum Ziel: Blättern Sie zum gewünschten Leuchtentyp, folgen Sie den Spalten von links nach rechts und treffen Sie dabei Ihre individuelle Auswahl. Am Ende steht die passende Artikelnummer zur direkten Bestellung bereit.

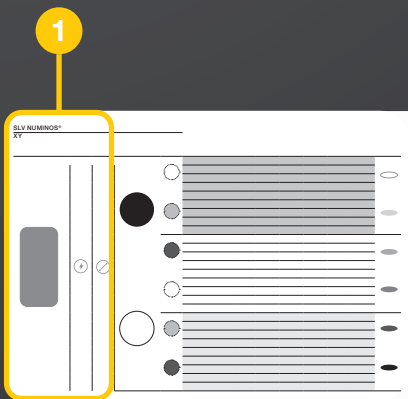

STEP 1

SPOTLIGHT ODER DOWNLIGHT?

Wählen Sie den passenden Leuchtentyp für Ihre Anforderung aus. Der Durchmesser (Downlights) bzw. die Gehäusegröße (Spotlights) sind dabei an die Systemleistung gekoppelt.

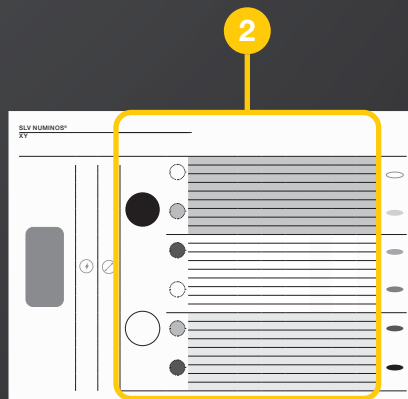

STEP 2

TECHNISCHE KONFIGURATION & DESIGN AUSWÄHLEN

Spalte für Spalte wählen Sie optische und technische Attribute wie Gehäuse- oder Dekoringfarben, die Farbtemperatur, Halbstreuwinkel und mehr aus.

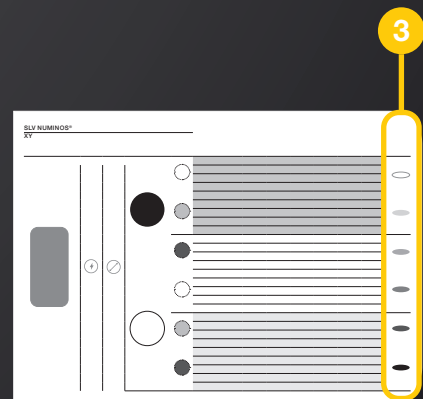

STEP 3

PRODUKT

Verschaffen Sie sich noch einen optischen Eindruck Ihrer fertig konfigurierten Leuchte, um sie gleich mit der passenden Artikelnummer zu bestellen.

NOCH ETWAS UNKLAR?



Scanne mich für ein Video, das anschaulich zeigt, wie einfach SLV NUMINOS® Leuchten zu konfigurieren sind.

Zusätzlich zu den bekannten Icons aus unserem Hauptkatalog BIG WHITE® finden Sie in diesem Kapitel folgende Icons:



Blendungsbewertung



Farbtemperatur



Halbstreuwinkel



Lumen



Steuerung

SLV NUMINOS® XS



DL

XS



Produktangaben:

200mA

Leistungsaufnahme: 7W

Material: Aluminium / Polycarbonat (PC)

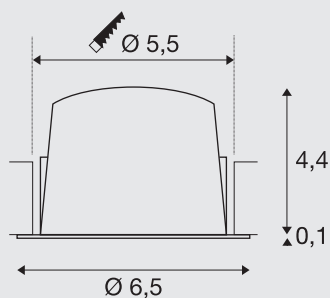

Hinweis:

Niederspannungsstecker

Treiber exkl.

Blattfedern liegen dem Produkt bei und können ausgetauscht werden.

Passende Treiber, Diffusoren und Reduzierringe finden Sie auf den Seiten 50-53.



■ schwarz

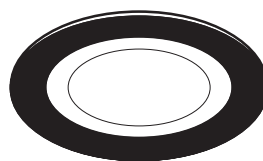

■ schwarz



□ weiß



■ chrom



■ schwarz

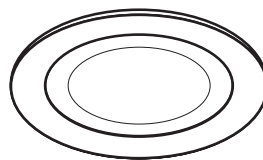

□ weiß



□ weiß





■ chrom



Blattfedern zur Installation
in massiven Decken liegen bei.



				ART. NR.		
2700K	640lm	20°	16	1005499		
	620lm	40°	22	1005502		
	640lm	55°	25	1005505		
3000K	700lm	20°	16	1005517		
	670lm	40°	22	1005520		
	690lm	55°	25	1005523		
4000K	720lm	20°	16	1005535		
	700lm	40°	22	1005538		
	710lm	55°	25	1005541		
2700K	670lm	20°	16	1005500		
	650lm	40°	22	1005503		
	670lm	55°	25	1005506		
3000K	730lm	20°	16	1005518		
	700lm	40°	22	1005521		
	720lm	55°	25	1005524		
4000K	750lm	20°	16	1005536		
	730lm	40°	22	1005539		
	740lm	55°	25	1005542		
2700K	670lm	20°	16	1005501		
	650lm	40°	22	1005504		
	670lm	55°	25	1005507		
3000K	730lm	20°	16	1005519		
	700lm	40°	22	1005522		
	720lm	55°	25	1005525		
4000K	750lm	20°	16	1005537		
	730lm	40°	22	1005540		
	740lm	55°	25	1005543		
2700K	640lm	20°	16	1005508		
	620lm	40°	22	1005511		
	640lm	55°	25	1005514		
3000K	700lm	20°	16	1005526		
	670lm	40°	22	1005529		
	690lm	55°	25	1005532		
4000K	720lm	20°	16	1005544		
	700lm	40°	22	1005547		
	710lm	55°	25	1005550		
2700K	670lm	20°	16	1005509		
	650lm	40°	22	1005512		
	670lm	55°	25	1005515		
3000K	730lm	20°	16	1005527		
	700lm	40°	22	1005530		
	720lm	55°	25	1005533		
4000K	750lm	20°	16	1005545		
	730lm	40°	22	1005548		
	740lm	55°	25	1005551		
2700K	670lm	20°	16	1005510		
	650lm	40°	22	1005513		
	670lm	55°	25	1005516		
3000K	730lm	20°	16	1005528		
	700lm	40°	22	1005531		
	720lm	55°	25	1005534		
4000K	750lm	20°	16	1005546		
	730lm	40°	22	1005549		
	740lm	55°	25	1005552		

SLV NUMINOS® S



DL

S



Produktangaben:

250mA

Leistungsaufnahme: 8,6W

Material: Aluminium / Polycarbonat (PC)

Einbaumaße: Ø: 6,8 cm T: 5,5 cm

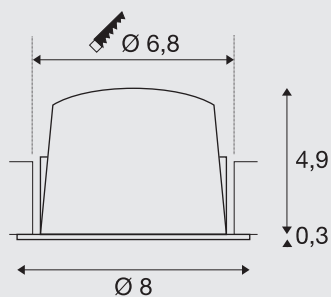

Hinweis:

Niederspannungsstecker

Treiber exkl.

Blattfedern liegen dem Produkt bei und können ausgetauscht werden.

Passende Treiber, Diffusoren und Reduzierringe finden Sie auf den Seiten 50-53.



schwarz

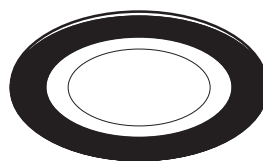

schwarz



weiß



chrom



schwarz

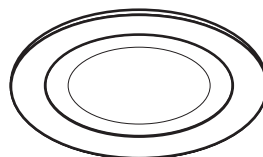

weiß



weiß



chrom



Blattfedern zur Installation
in massiven Decken liegen bei.



				ART. NR.	
2700K	670lm	20°	19	1003769	
	670lm	40°	18,5	1003772	
	670lm	55°	22	1003775	
3000K	690lm	20°	19	1003793	
	690lm	40°	19	1003796	
	690lm	55°	22	1003799	
4000K	730lm	20°	19	1003817	
	730lm	40°	19	1003820	
	730lm	55°	22	1003823	
2700K	720lm	20°	18,5	1003770	
	720lm	40°	19	1003773	
	720lm	55°	22	1003776	
3000K	730lm	20°	19	1003794	
	730lm	40°	19	1003797	
	730lm	55°	22	1003800	
4000K	790lm	20°	19	1003818	
	790lm	40°	19	1003821	
	790lm	55°	22	1003824	
2700K	690lm	20°	19	1003771	
	690lm	40°	19	1003774	
	690lm	55°	22	1003777	
3000K	700lm	20°	19	1003795	
	700lm	40°	19	1003798	
	700lm	55°	19	1003801	
4000K	750lm	20°	19	1003819	
	750lm	40°	19	1003822	
	750lm	55°	22	1003825	
2700K	670lm	20°	19	1003781	
	670lm	40°	19	1003784	
	670lm	55°	22	1003787	
3000K	690lm	20°	19	1003805	
	690lm	40°	19	1003808	
	690lm	55°	22	1003811	
4000K	730lm	20°	19	1003829	
	730lm	40°	19	1003832	
	730lm	55°	22	1003835	
2700K	720lm	20°	18,5	1003782	
	720lm	40°	19	1003785	
	720lm	55°	22	1003788	
3000K	730lm	20°	19	1003806	
	730lm	40°	19	1003809	
	730lm	55°	22	1003812	
4000K	790lm	20°	19	1003830	
	790lm	40°	19	1003833	
	790lm	55°	22	1003836	
2700K	690lm	20°	19	1003783	
	690lm	40°	19	1003786	
	690lm	55°	22	1003789	
3000K	700lm	20°	19	1003807	
	700lm	40°	19	1003810	
	700lm	55°	22	1003813	
4000K	750lm	20°	19	1003831	
	750lm	40°	19	1003834	
	750lm	55°	22	1003837	

SLV NUMINOS® M



DL

M



Produktangaben:

500mA

Leistungsaufnahme: 17,5W

Material: Aluminium / Polycarbonat (PC)

Einbaumaße: Ø: 9 cm T: 7,5 cm

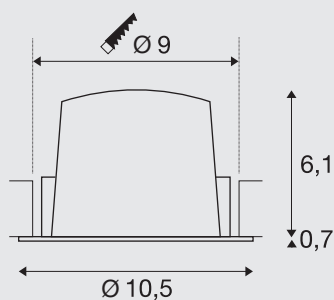

Hinweis:

Niederspannungsstecker

Treiber exkl.

Blattfedern liegen dem Produkt bei und können ausgetauscht werden.

Passende Treiber, Diffusoren und Reduzierringe finden Sie auf den Seiten 50-53.



schwarz

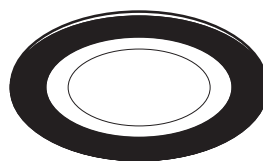

schwarz



weiß



chrom



schwarz

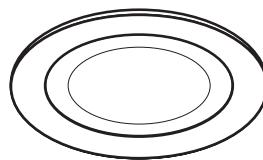

weiß



weiß



chrom



Blattfedern zur Installation
in massiven Decken liegen bei.



				ART. NR.	
2700K	1460lm	20°	19	1003841	
	1460lm	40°	22	1003844	
	1460lm	55°	22	1003847	
3000K	1500lm	20°	19	1003865	
	1500lm	40°	22	1003868	
	1500lm	55°	22	1003871	
4000K	1600lm	20°	19	1003889	
	1600lm	40°	22	1003892	
	1600lm	55°	22	1003895	
2700K	1600lm	20°	22	1003842	
	1600lm	40°	19,4	1003845	
	1600lm	55°	22	1003848	
3000K	1600lm	20°	22	1003866	
	1600lm	40°	22	1003869	
	1600lm	55°	22	1003872	
4000K	1750lm	20°	22	1003890	
	1750lm	40°	22	1003893	
	1750lm	55°	22	1003896	
2700K	1550lm	20°	19	1003843	
	1550lm	40°	19	1003846	
	1550lm	55°	19	1003849	
3000K	1550lm	20°	19	1003867	
	1550lm	40°	19	1003870	
	1550lm	55°	19	1003873	
4000K	1660lm	20°	19	1003891	
	1660lm	40°	19	1003894	
	1660lm	55°	19	1003897	
2700K	1460lm	20°	19	1003853	
	1460lm	40°	22	1003856	
	1460lm	55°	22	1003859	
3000K	1500lm	20°	19	1003877	
	1500lm	40°	22	1003880	
	1500lm	55°	22	1003883	
4000K	1600lm	20°	19	1003901	
	1600lm	40°	22	1003904	
	1600lm	55°	22	1003907	
2700K	1600lm	20°	22	1003854	
	1600lm	40°	19	1003857	
	1600lm	55°	22	1003860	
3000K	1600lm	20°	22	1003878	
	1600lm	40°	22	1003881	
	1600lm	55°	22	1003884	
4000K	1750lm	20°	22	1003902	
	1750lm	40°	22	1003905	
	1750lm	55°	22	1003908	
2700K	1550lm	20°	19	1003855	
	1550lm	40°	19	1003858	
	1550lm	55°	19	1003861	
3000K	1550lm	20°	19	1003879	
	1550lm	40°	19	1003882	
	1550lm	55°	19	1003885	
4000K	1660lm	20°	19	1003903	
	1660lm	40°	19	1003906	
	1660lm	55°	19	1003909	

SLV NUMINOS® L



DL



Produktangaben:

700mA

Leistungsaufnahme: 25,4W

Material: Aluminium / Polycarbonat (PC)

Einbaumaße: Ø: 11,7 cm T: 9 cm

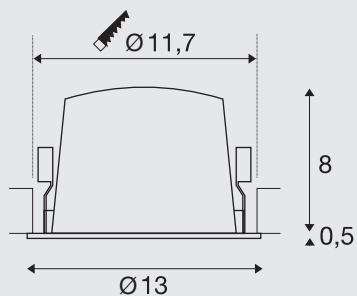

Hinweis:

Niederspannungsstecker

Treiber exkl.

Passende Treiber, Diffusoren und Reduzierringe finden Sie auf den Seiten 50-53.



schwarz

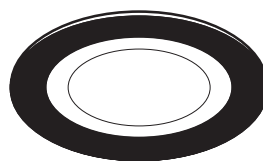

schwarz



weiß



chrom



schwarz

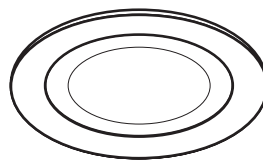

weiß



weiß



chrom





ART. NR.

2700K	2150lm	20°	22	1003913
	2150lm	40°	22	1003916
	2150lm	55°	22	1003919
3000K	2150lm	20°	22	1003937
	2150lm	40°	22	1003940
	2150lm	55°	25	1003943
4000K	2350lm	20°	22	1003961
	2350lm	40°	22	1003964
	2350lm	55°	25	1003967
2700K	2250lm	20°	19	1003914
	2250lm	40°	19	1003917
	2250lm	55°	22	1003920
3000K	2300lm	20°	19	1003938
	2300lm	40°	19	1003941
	2300lm	55°	20	1003944
4000K	2450lm	20°	19	1003962
	2450lm	40°	19	1003965
	2450lm	55°	22	1003968
2700K	2150lm	20°	19	1003915
	2150lm	40°	19	1003918
	2150lm	55°	19	1003921
3000K	2200lm	20°	19	1003939
	2200lm	40°	19	1003942
	2200lm	55°	19	1003945
4000K	2350lm	20°	19	1003963
	2350lm	40°	19	1003966
	2350lm	55°	19	1003969
2700K	2150lm	20°	22	1003925
	2150lm	40°	22	1003928
	2150lm	55°	22	1003931
3000K	2150lm	20°	22	1003949
	2150lm	40°	22	1003952
	2150lm	55°	25	1003955
4000K	2350lm	20°	22	1003973
	2350lm	40°	22	1003976
	2350lm	55°	25	1003979
2700K	2250lm	20°	19	1003926
	2250lm	40°	19	1003929
	2250lm	55°	22	1003932
3000K	2300lm	20°	19	1003950
	2300lm	40°	19	1003953
	2300lm	55°	22	1003956
4000K	2450lm	20°	19	1003974
	2450lm	40°	19	1003977
	2450lm	55°	22	1003980
2700K	2150lm	20°	19	1003927
	2150lm	40°	19	1003930
	2150lm	55°	19	1003933
3000K	2200lm	20°	19	1003951
	2200lm	40°	19	1003954
	2200lm	55°	19	1003957
4000K	2350lm	20°	19	1003975
	2350lm	40°	19	1003978
	2350lm	55°	19	1003981



SLV NUMINOS® XL



DL

XL



Produktangaben:

1050mA

Leistungsaufnahme: 37,4W

Material: Aluminium / Polycarbonat (PC)

Einbaumaße: Ø: 14,5 cm T: 11,5 cm

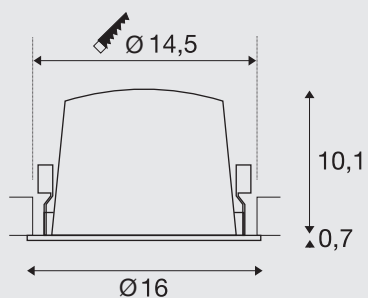

Hinweis:

Niederspannungsstecker

Treiber exkl.

Passende Treiber, Diffusoren und Reduzierringe finden Sie auf den Seiten 50-53.



schwarz

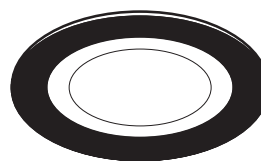

schwarz



weiß



chrom



schwarz

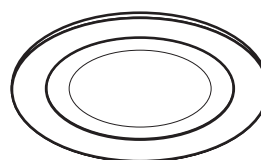

weiß



weiß



chrom



ART. NR.

2700K	3300lm	20°	22	1003985
	3300lm	40°	22	1003988
	3300lm	55°	22	1003991
3000K	3300lm	20°	22	1004009
	3300lm	40°	22	1004012
	3300lm	55°	22	1004015
4000K	3600lm	20°	22	1004033
	3600lm	40°	22	1004036
	3600lm	55°	25	1004039
2700K	3500lm	20°	19	1003986
	3500lm	40°	19	1003989
	3500lm	55°	19	1003992
3000K	3550lm	20°	19	1004010
	3550lm	40°	19	1004013
	3550lm	55°	19	1004016
4000K	3800lm	20°	19	1004034
	3800lm	40°	19	1004037
	3800lm	55°	19	1004040
2700K	3400lm	20°	19	1003987
	3400lm	40°	19	1003990
	3400lm	55°	19	1003993
3000K	3500lm	20°	19	1004011
	3500lm	40°	19	1004014
	3500lm	55°	19	1004017
4000K	3750lm	20°	19	1004035
	3750lm	40°	19	1004038
	3750lm	55°	19	1004041
2700K	3300lm	20°	22	1003997
	3300lm	40°	22	1004000
	3300lm	55°	22	1004003
3000K	3300lm	20°	22	1004021
	3300lm	40°	22	1004024
	3300lm	55°	22	1004027
4000K	3600lm	20°	22	1004045
	3600lm	40°	22	1004048
	3600lm	55°	25	1004051
2700K	3500lm	20°	19	1003998
	3500lm	40°	19	1004001
	3500lm	55°	19	1004004
3000K	3550lm	20°	19	1004022
	3550lm	40°	19	1004025
	3550lm	55°	19	1004028
4000K	3800lm	20°	19	1004046
	3800lm	40°	19	1004049
	3800lm	55°	19	1004052
2700K	3400lm	20°	19	1003999
	3400lm	40°	19	1004002
	3400lm	55°	19	1004005
3000K	3500lm	20°	19	1004023
	3500lm	40°	19	1004026
	3500lm	55°	19	1004029
4000K	3750lm	20°	19	1004047
	3750lm	40°	19	1004050
	3750lm	55°	19	1004053



SLV NUMINOS® MOVE XS



DL

XS



Produktangaben:

200mA

Leistungsaufnahme: 7W

Material: Aluminium / Polycarbonat (PC)

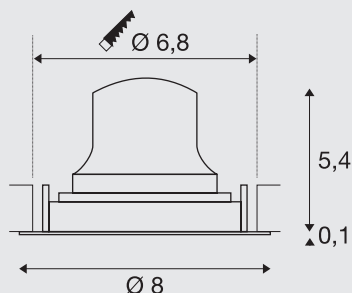

Hinweis:

Niederspannungsstecker

Treiber exkl.

Passende Treiber, Diffusoren und Reduzierringe finden Sie auf den Seiten 50-53.



schwarz

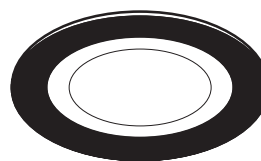

schwarz



weiß



chrom



schwarz

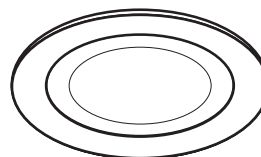

weiß



weiß



chrom



ART. NR.

2700K	640 lm	20°	16	1005553		
	620 lm	40°	22	1005556		
	640 lm	55°	25	1005559		
3000K	700 lm	20°	16	1005571		
	670 lm	40°	22	1005574		
	690 lm	55°	25	1005577		
4000K	720 lm	20°	16	1005589		
	700 lm	40°	22	1005592		
	710 lm	55°	25	1005595		
2700K	670 lm	20°	16	1005554		
	650 lm	40°	22	1005557		
	670 lm	55°	25	1005560		
3000K	730 lm	20°	16	1005572		
	700 lm	40°	22	1005575		
	720 lm	55°	25	1005578		
4000K	750 lm	20°	16	1005590		
	730 lm	40°	22	1005593		
	740 lm	55°	25	1005596		
2700K	670 lm	20°	16	1005555		
	650 lm	40°	22	1005558		
	670 lm	55°	25	1005561		
3000K	730 lm	20°	16	1005573		
	700 lm	40°	22	1005576		
	720 lm	55°	25	1005579		
4000K	750 lm	20°	16	1005591		
	730 lm	40°	22	1005594		
	740 lm	55°	25	1005597		
2700K	640 lm	20°	16	1005562		
	620 lm	40°	22	1005565		
	640 lm	55°	25	1005568		
3000K	700 lm	20°	16	1005580		
	670 lm	40°	22	1005583		
	690 lm	55°	25	1005586		
4000K	720 lm	20°	16	1005598		
	700 lm	40°	22	1005603		
	710 lm	55°	25	1005606		
2700K	670 lm	20°	16	1005563		
	650 lm	40°	22	1005566		
	670 lm	55°	25	1005569		
3000K	730 lm	20°	16	1005581		
	700 lm	40°	22	1005584		
	720 lm	55°	25	1005587		
4000K	750 lm	20°	16	1005599		
	730 lm	40°	22	1005604		
	740 lm	55°	25	1005607		
2700K	670 lm	20°	16	1005564		
	650 lm	40°	22	1005567		
	670 lm	55°	25	1005570		
3000K	730 lm	20°	16	1005582		
	700 lm	40°	22	1005585		
	720 lm	55°	25	1005588		
4000K	750 lm	20°	16	1005600		
	730 lm	40°	22	1005605		
	740 lm	55°	25	1005608		

SLV NUMINOS® MOVE S



DL

S



Produktangaben:

250 mA

Leistungsaufnahme: 8,6W

Material: Aluminium / Polycarbonat (PC)

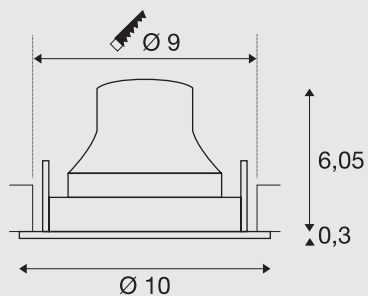

Hinweis:

Niederspannungsstecker
Treiber exkl.

Passende Treiber, Diffusoren und Reduzierringe finden Sie auf den Seiten 50-53.



schwarz

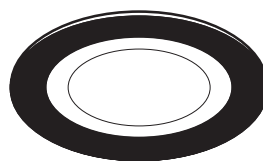

schwarz



weiß



chrom



schwarz

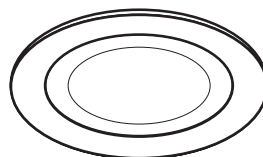

weiß



weiß



chrom



ART. NR.

2700K	670lm	20°	19	1005319
	670lm	40°	19	1005322
	670lm	55°	22	1005325
3000K	690lm	20°	19	1005337
	690lm	40°	19	1005340
	690lm	55°	22	1005343
4000K	730lm	20°	19	1005355
	730lm	40°	19	1005358
	730lm	55°	22	1005361
2700K	720lm	20°	19	1005320
	720lm	40°	19	1005323
	720lm	55°	22	1005326
3000K	730lm	20°	19	1005338
	730lm	40°	19	1005341
	730lm	55°	22	1005344
4000K	790lm	20°	19	1005356
	790lm	40°	19	1005359
	790lm	55°	22	1005362
2700K	690lm	20°	19	1005321
	690lm	40°	19	1005324
	690lm	55°	22	1005327
3000K	700lm	20°	19	1005339
	700lm	40°	19	1005342
	700lm	55°	22	1005345
4000K	750lm	20°	19	1005357
	750lm	40°	19	1005360
	750lm	55°	22	1005363
2700K	670lm	20°	19	1005328
	670lm	40°	19	1005331
	670lm	55°	22	1005334
3000K	690lm	20°	19	1005346
	690lm	40°	19	1005349
	690lm	55°	22	1005352
4000K	730lm	20°	19	1005364
	730lm	40°	19	1005367
	730lm	55°	22	1005370
2700K	720lm	20°	19	1005329
	720lm	40°	19	1005332
	720lm	55°	22	1005335
3000K	730lm	20°	19	1005347
	730lm	40°	19	1005350
	730lm	55°	22	1005353
4000K	790lm	20°	19	1005365
	790lm	40°	19	1005368
	790lm	55°	22	1005371
2700K	690lm	20°	19	1005330
	690lm	40°	19	1005333
	690lm	55°	22	1005336
3000K	700lm	20°	19	1005348
	700lm	40°	19	1005351
	700lm	55°	22	1005354
4000K	750lm	20°	19	1005366
	750lm	40°	19	1005369
	750lm	55°	22	1005372



SLV NUMINOS® MOVE M DL



M



Produktangaben:

500mA

Leistungsaufnahme: 17,5W

Material: Aluminium / Polycarbonat (PC)

Einbaumaße: Ø: 12 cm T: 10 cm

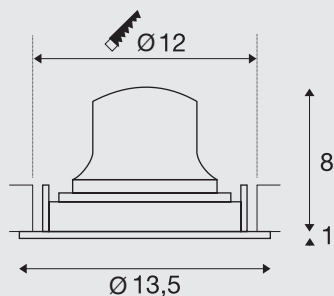

Hinweis:

Niederspannungsstecker

Treiber exkl.

Passende Treiber, Diffusoren und Reduzierringe finden Sie auf den Seiten 50-53.



schwarz

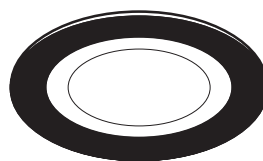

schwarz



weiß



chrom



schwarz

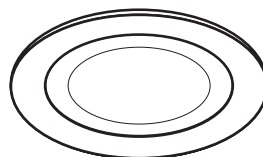

weiß



weiß



chrom



ART. NR.

2700K	1460lm	20°	19	1003553
	1460lm	40°	22	1003556
	1460lm	55°	22	1003559
3000K	1500lm	20°	19	1003577
	1500lm	40°	22	1003580
	1500lm	55°	22	1003583
4000K	1600lm	20°	19	1003601
	1600lm	40°	22	1003604
	1600lm	55°	22	1003607
2700K	1600lm	20°	22	1003554
	1600lm	40°	19	1003557
	1600lm	55°	22	1003560
3000K	1600lm	20°	22	1003578
	1600lm	40°	22	1003581
	1600lm	55°	22	1003584
4000K	1750lm	20°	22	1003602
	1750lm	40°	22	1003605
	1750lm	55°	22	1003608
2700K	1550lm	20°	19	1003555
	1550lm	40°	19	1003558
	1550lm	55°	19	1003561
3000K	1550lm	20°	19	1003579
	1550lm	40°	19	1003582
	1550lm	55°	19	1003585
4000K	1660lm	20°	19	1003603
	1660lm	40°	19	1003606
	1660lm	55°	19	1003609
2700K	1460lm	20°	19	1003565
	1460lm	40°	22	1003568
	1460lm	55°	22	1003571
3000K	1500lm	20°	19	1003589
	1500lm	40°	22	1003592
	1500lm	55°	22	1003595
4000K	1600lm	20°	19	1003613
	1600lm	40°	22	1003616
	1600lm	55°	22	1003619
2700K	1600lm	20°	22	1003566
	1600lm	40°	22	1003569
	1600lm	55°	22	1003572
3000K	1600lm	20°	22	1003590
	1600lm	40°	22	1003593
	1600lm	55°	22	1003596
4000K	1750lm	20°	22	1003614
	1750lm	40°	22	1003617
	1750lm	55°	22	1003620
2700K	1550lm	20°	19	1003567
	1550lm	40°	19	1003570
	1550lm	55°	19	1003573
3000K	1550lm	20°	19	1003591
	1550lm	40°	19	1003594
	1550lm	55°	19	1003597
4000K	1660lm	20°	19	1003615
	1660lm	40°	19	1003618
	1660lm	55°	19	1003621



SLV NUMINOS® MOVE L

DL



Produktangaben:

750mA

Leistungsaufnahme: 25,4W

Material: Aluminium / Polycarbonat (PC)

Einbaumaße: Ø: 14,5 cm T: 10,5 cm

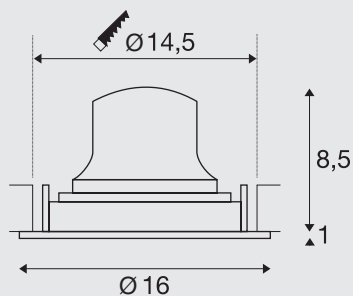

Hinweis:

Niederspannungsstecker
Treiber exkl.

Passende Treiber, Diffusoren und Reduzierringe finden Sie auf den Seiten 50-53.



schwarz

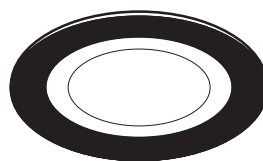

schwarz



weiß



chrom



schwarz

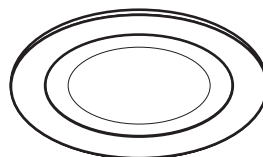

weiß



weiß



chrom



ART. NR.

2700K	2150lm	20°	22	1003625
	2150lm	40°	22	1003628
	2150lm	55°	22	1003631
3000K	2150lm	20°	22	1003649
	2150lm	40°	22	1003652
	2150lm	55°	25	1003655
4000K	2350lm	20°	22	1003673
	2350lm	40°	22	1003676
	2350lm	55°	25	1003679
2700K	2250lm	20°	19	1003626
	2250lm	40°	19	1003629
	2250lm	55°	22	1003632
3000K	2300lm	20°	19	1003650
	2300lm	40°	19	1003653
	2300lm	55°	22	1003656
4000K	2450lm	20°	19	1003674
	2450lm	40°	19	1003677
	2450lm	55°	22	1003680
2700K	2150lm	20°	19	1003627
	2150lm	40°	19	1003630
	2150lm	55°	19	1003633
3000K	2200lm	20°	19	1003651
	2200lm	40°	19	1003654
	2200lm	55°	19	1003657
4000K	2350lm	20°	19	1003675
	2350lm	40°	19	1003678
	2350lm	55°	19	1003681
2700K	2150lm	20°	22	1003637
	2150lm	40°	22	1003640
	2150lm	55°	22	1003643
3000K	2150lm	20°	22	1003661
	2150lm	40°	22	1003664
	2150lm	55°	25	1003667
4000K	2350lm	20°	22	1003685
	2350lm	40°	22	1003688
	2350lm	55°	25	1003691
2700K	2250lm	20°	19	1003638
	2250lm	40°	19	1003641
	2250lm	55°	22	1003644
3000K	2300lm	20°	19	1003662
	2300lm	40°	19	1003665
	2300lm	55°	22	1003668
4000K	2450lm	20°	19	1003686
	2450lm	40°	19	1003689
	2450lm	55°	22	1003692
2700K	2150lm	20°	19	1003639
	2150lm	40°	19	1003642
	2150lm	55°	19	1003645
3000K	2200lm	20°	19	1003663
	2200lm	40°	19	1003666
	2200lm	55°	19	1003669
4000K	2350lm	20°	19	1003687
	2350lm	40°	19	1003690
	2350lm	55°	19	1003693



SLV NUMINOS® MOVE XL



DL

XL



Produktangaben:

1050mA

Leistungsaufnahme: 37,4W

Material: Aluminium / Polycarbonat (PC)

Einbaumaße: Ø: 17,5 cm T: 13 cm

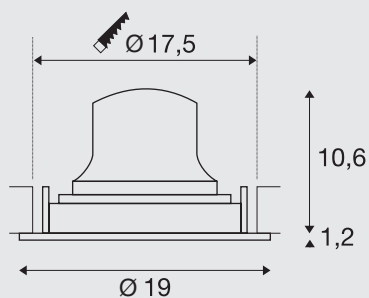

Hinweis:

Niederspannungsstecker

Treiber exkl.

Passende Treiber, Diffusoren und Reduzierringe finden Sie auf den Seiten 50-53.



schwarz

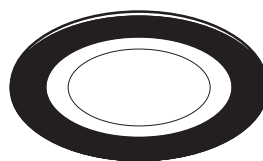

schwarz



weiß



chrom



schwarz

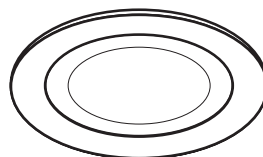

weiß



weiß



chrom



ART. NR.

2700K	3300lm	20°	22	1003697
	3300lm	40°	22	1003700
	3300lm	55°	22	1003703
3000K	3300lm	20°	22	1003721
	3300lm	40°	22	1003724
	3300lm	55°	22	1003727
4000K	3600lm	20°	22	1003745
	3600lm	40°	22	1003748
	3600lm	55°	25	1003751
2700K	3500lm	20°	19	1003698
	3500lm	40°	19	1003701
	3500lm	55°	19	1003704
3000K	3550lm	20°	19	1003722
	3550lm	40°	19	1003725
	3550lm	55°	19	1003728
4000K	3800lm	20°	19	1003746
	3800lm	40°	19	1003749
	3800lm	55°	19	1003752
2700K	3400lm	20°	19	1003699
	3400lm	40°	19	1003702
	3400lm	55°	19	1003705
3000K	3500lm	20°	19	1003723
	3500lm	40°	19	1003726
	3500lm	55°	19	1003729
4000K	3750lm	20°	19	1003747
	3750lm	40°	19	1003750
	3750lm	55°	19	1003753
2700K	3300lm	20°	22	1003709
	3300lm	40°	22	1003712
	3300lm	55°	22	1003715
3000K	3300lm	20°	22	1003733
	3300lm	40°	22	1003736
	3300lm	55°	22	1003739
4000K	3600lm	20°	22	1003757
	3600lm	40°	22	1003760
	3600lm	55°	25	1003763
2700K	3500lm	20°	19	1003710
	3500lm	40°	19	1003713
	3500lm	55°	19	1003716
3000K	3550lm	20°	19	1003734
	3550lm	40°	19	1003737
	3550lm	55°	19	1003740
4000K	3800lm	20°	19	1003758
	3800lm	40°	19	1003761
	3800lm	55°	19	1003764
2700K	3400lm	20°	19	1003711
	3400lm	40°	19	1003714
	3400lm	55°	19	1003717
3000K	3500lm	20°	19	1003735
	3500lm	40°	19	1003738
	3500lm	55°	19	1003741
4000K	3750lm	20°	19	1003759
	3750lm	40°	19	1003762
	3750lm	55°	19	1003765



SLV NUMINOS® GIMBLE XS



DL

XS



Produktangaben:

200mA

Leistungsaufnahme: 7W

Material: Aluminium / Polycarbonat (PC)

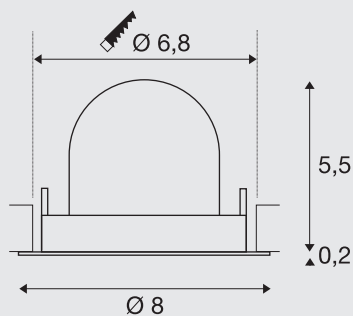
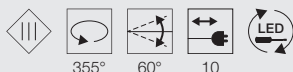

Hinweis:

Niederspannungsstecker

Treiber exkl.

Passende Treiber, Diffusoren und Reduzierringe finden Sie auf den Seiten 50-53.



schwarz

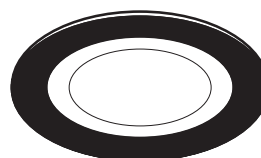

schwarz



weiß



chrom



schwarz

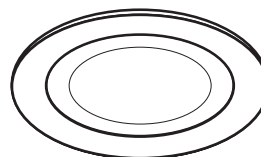

weiß



weiß



chrom



ART. NR.

2700K	640lm	20°	16	1005813		
	620lm	40°	22	1005816		
	640lm	55°	25	1005819		
3000K	700lm	20°	16	1005831		
	670lm	40°	22	1005834		
	690lm	55°	25	1005837		
4000K	720lm	20°	16	1005849		
	700lm	40°	22	1005852		
	710lm	55°	25	1005855		
2700K	670lm	20°	16	1005814		
	650lm	40°	22	1005817		
	670lm	55°	25	1005820		
3000K	730lm	20°	16	1005832		
	700lm	40°	22	1005835		
	720lm	55°	25	1005838		
4000K	750lm	20°	16	1005850		
	730lm	40°	22	1005853		
	740lm	55°	25	1005856		
2700K	670lm	20°	16	1005815		
	650lm	40°	22	1005818		
	670lm	55°	25	1005821		
3000K	730lm	20°	16	1005833		
	700lm	40°	22	1005836		
	720lm	55°	25	1005839		
4000K	750lm	20°	16	1005851		
	730lm	40°	22	1005854		
	740lm	55°	25	1005857		
2700K	640lm	20°	16	1005822		
	620lm	40°	22	1005825		
	640lm	55°	25	1005828		
3000K	700lm	20°	16	1005840		
	670lm	40°	22	1005843		
	690lm	55°	25	1005846		
4000K	720lm	20°	16	1005858		
	700lm	40°	22	1005861		
	710lm	55°	25	1005864		
2700K	670lm	20°	16	1005823		
	650lm	40°	22	1005826		
	670lm	55°	25	1005829		
3000K	730lm	20°	16	1005841		
	700lm	40°	22	1005844		
	720lm	55°	25	1005847		
4000K	750lm	20°	16	1005859		
	730lm	40°	22	1005862		
	740lm	55°	25	1005865		
2700K	670lm	20°	16	1005824		
	650lm	40°	22	1005827		
	670lm	55°	25	1005830		
3000K	730lm	20°	16	1005842		
	700lm	40°	22	1005845		
	720lm	55°	25	1005848		
4000K	750lm	20°	16	1005860		
	730lm	40°	22	1005863		
	740lm	55°	25	1005866		

SLV NUMINOS® GIMBLE S DL



S



Produktangaben:

250mA

Leistungsaufnahme: 8,6 W

Material: Aluminium / Polycarbonat (PC)

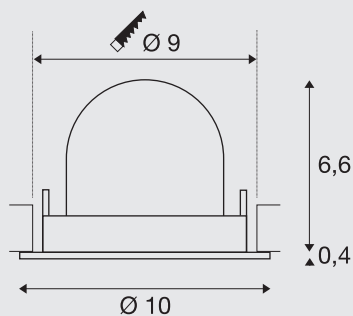
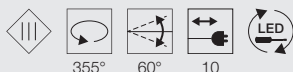

Hinweis:

Niederspannungsstecker
Treiber exkl.

Passende Treiber, Diffusoren und Reduzierringe finden Sie auf den Seiten 50-53.



schwarz

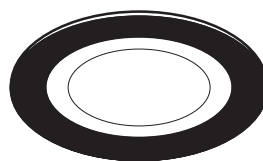

schwarz



weiß



chrom



schwarz

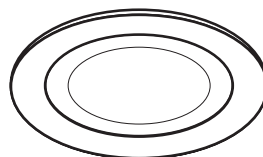

weiß



weiß



chrom



ART. NR.

2700K	670lm	20°	19	1005867
	670lm	40°	19	1005870
	670lm	55°	22	1005873
3000K	690lm	20°	19	1005885
	690lm	40°	19	1005888
	690lm	55°	22	1005891
4000K	730lm	20°	19	1005903
	730lm	40°	19	1005906
	730lm	55°	22	1005909
2700K	720lm	20°	19	1005868
	720lm	40°	19	1005871
	720lm	55°	22	1005874
3000K	730lm	20°	19	1005886
	730lm	40°	19	1005889
	730lm	55°	22	1005892
4000K	790lm	20°	19	1005904
	790lm	40°	19	1005907
	790lm	55°	22	1005910
2700K	690lm	20°	19	1005869
	690lm	40°	19	1005872
	690lm	55°	22	1005875
3000K	700lm	20°	19	1005887
	700lm	40°	19	1005890
	700lm	55°	22	1005893
4000K	750lm	20°	19	1005905
	750lm	40°	19	1005908
	750lm	55°	22	1005911
2700K	670lm	20°	19	1005876
	670lm	40°	19	1005879
	670lm	55°	22	1005882
3000K	690lm	20°	19	1005894
	690lm	40°	19	1005897
	690lm	55°	22	1005900
4000K	730lm	20°	19	1005912
	730lm	40°	19	1005915
	730lm	55°	22	1005918
2700K	720lm	20°	19	1005877
	720lm	40°	19	1005880
	720lm	55°	22	1005883
3000K	730lm	20°	19	1005895
	730lm	40°	19	1005898
	730lm	55°	22	1005901
4000K	790lm	20°	19	1005913
	790lm	40°	19	1005916
	790lm	55°	22	1005919
2700K	690lm	20°	19	1005878
	690lm	40°	19	1005881
	690lm	55°	22	1005884
3000K	700lm	20°	19	1005896
	700lm	40°	19	1005899
	700lm	55°	22	1005902
4000K	750lm	20°	19	1005914
	750lm	40°	19	1005917
	750lm	55°	22	1005920



SLV NUMINOS® GIMBLE M DL



M



Produktangaben:

500mA

Leistungsaufnahme: 17,5W

Material: Aluminium / Polycarbonat (PC)

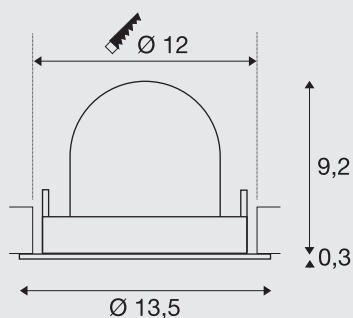
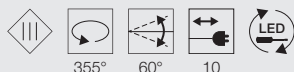

Hinweis:

Niederspannungsstecker
Treiber exkl.

Passende Treiber, Diffusoren und
Reduzierringe finden Sie auf den Seiten 50-53.



schwarz

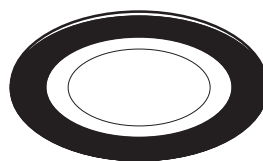

schwarz



weiß



chrom



schwarz

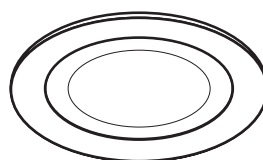

weiß



weiß



chrom



ART. NR.

2700K	1460lm	20°	22	1005921
	1460lm	40°	22	1005924
	1460lm	55°	22	1005927
3000K	1500lm	20°	22	1005939
	1500lm	40°	22	1005942
	1500lm	55°	22	1005945
4000K	1600lm	20°	22	1005957
	1600lm	40°	22	1005960
	1600lm	55°	22	1005963
2700K	1600lm	20°	22	1005922
	1600lm	40°	22	1005925
	1600lm	55°	22	1005928
3000K	1600lm	20°	22	1005940
	1600lm	40°	22	1005943
	1600lm	55°	22	1005946
4000K	1750lm	20°	22	1005958
	1750lm	40°	22	1005961
	1750lm	55°	22	1005964
2700K	1550lm	20°	22	1005923
	1550lm	40°	22	1005926
	1550lm	55°	22	1005929
3000K	1550lm	20°	22	1005941
	1550lm	40°	22	1005944
	1550lm	55°	22	1005947
4000K	1660lm	20°	22	1005959
	1660lm	40°	22	1005962
	1660lm	55°	22	1005965
2700K	1460lm	20°	22	1005930
	1460lm	40°	22	1005933
	1460lm	55°	22	1005936
3000K	1500lm	20°	22	1005948
	1500lm	40°	22	1005951
	1500lm	55°	22	1005954
4000K	1600lm	20°	22	1005966
	1600lm	40°	22	1005969
	1600lm	55°	22	1005972
2700K	1600lm	20°	22	1005931
	1600lm	40°	22	1005934
	1600lm	55°	22	1005937
3000K	1600lm	20°	22	1005949
	1600lm	40°	22	1005952
	1600lm	55°	22	1005955
4000K	1750lm	20°	22	1005967
	1750lm	40°	22	1005970
	1750lm	55°	22	1005973
2700K	1550lm	20°	22	1005932
	1550lm	40°	22	1005935
	1550lm	55°	22	1005938
3000K	1550lm	20°	22	1005950
	1550lm	40°	22	1005953
	1550lm	55°	22	1005956
4000K	1660lm	20°	22	1005968
	1660lm	40°	22	1005971
	1660lm	55°	22	1005974



SLV NUMINOS® GIMBLE L DL



Produktangaben:

700mA

Leistungsaufnahme: 25,4W

Material: Aluminium / Polycarbonat (PC)

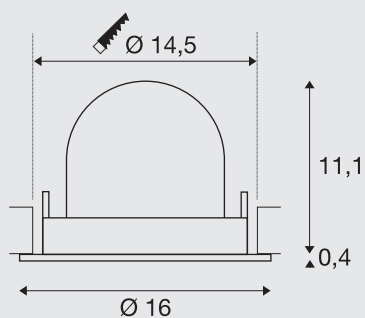
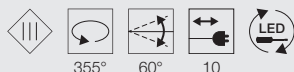

Hinweis:

Niederspannungsstecker
Treiber exkl.

Passende Treiber, Diffusoren und Reduzierringe finden Sie auf den Seiten 50-53.



■ schwarz

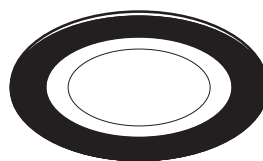

■ schwarz



□ weiß



■ chrom



■ schwarz

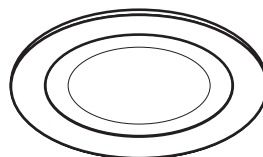

□ weiß



□ weiß



■ chrom



ART. NR.

2700K	2150lm	20°	22	1005975
	2150lm	40°	22	1005978
	2150lm	55°	22	1005981
3000K	2150lm	20°	22	1005993
	2150lm	40°	22	1005996
	2150lm	55°	22	1005999
4000K	2350lm	20°	22	1006011
	2350lm	40°	22	1006014
	2350lm	55°	22	1006017
2700K	2250lm	20°	22	1005976
	2250lm	40°	22	1005979
	2250lm	55°	22	1005982
3000K	2300lm	20°	22	1005994
	2300lm	40°	22	1005997
	2300lm	55°	22	1006000
4000K	2450lm	20°	22	1006012
	2450lm	40°	22	1006015
	2450lm	55°	22	1006018
2700K	2150lm	20°	22	1005977
	2150lm	40°	22	1005980
	2150lm	55°	22	1005983
3000K	2200lm	20°	22	1005995
	2200lm	40°	22	1005998
	2200lm	55°	22	1006001
4000K	2350lm	20°	22	1006013
	2350lm	40°	22	1006016
	2350lm	55°	22	1006019
2700K	2150lm	20°	22	1005984
	2150lm	40°	22	1005987
	2150lm	55°	22	1005990
3000K	2150lm	20°	22	1006002
	2150lm	40°	22	1006005
	2150lm	55°	22	1006008
4000K	2350lm	20°	22	1006020
	2350lm	40°	22	1006023
	2350lm	55°	22	1006026
2700K	2250lm	20°	22	1005985
	2250lm	40°	22	1005988
	2250lm	55°	22	1005991
3000K	2300lm	20°	22	1006003
	2300lm	40°	22	1006006
	2300lm	55°	22	1006009
4000K	2450lm	20°	22	1006021
	2450lm	40°	22	1006024
	2450lm	55°	22	1006027
2700K	2150lm	20°	22	1005986
	2150lm	40°	22	1005989
	2150lm	55°	22	1005992
3000K	2200lm	20°	22	1006004
	2200lm	40°	22	1006007
	2200lm	55°	22	1006010
4000K	2350lm	20°	22	1006022
	2350lm	40°	22	1006025
	2350lm	55°	22	1006028



SLV NUMINOS® GIMBLE XL



DL

XL



Produktangaben:

1000/1050mA

Leistungsaufnahme: 37,4W

Material: Aluminium / Polycarbonat (PC)

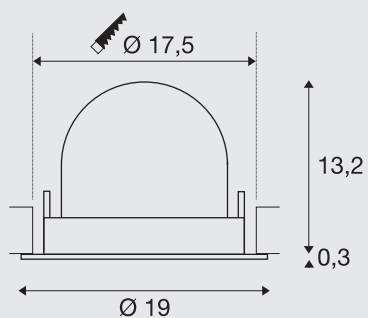
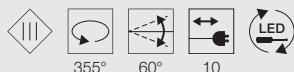

Hinweis:

Niederspannungsstecker
Treiber exkl.

Passende Treiber, Diffusoren und Reduzierringe finden Sie auf den Seiten 50-53.



schwarz

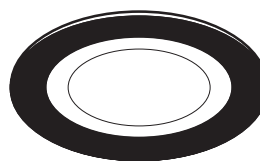

schwarz



weiß



chrom



schwarz

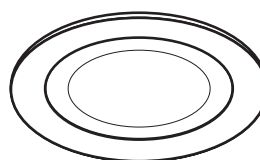

weiß



weiß



chrom



ART. NR.

2700K	3300lm	20°	22	1006029
	3300lm	40°	22	1006032
	3300lm	55°	22	1006035
3000K	3300lm	20°	22	1006047
	3300lm	40°	22	1006050
	3300lm	55°	22	1006053
4000K	3600lm	20°	22	1006065
	3600lm	40°	22	1006068
	3600lm	55°	22	1006071
2700K	3500lm	20°	22	1006030
	3500lm	40°	22	1006033
	3500lm	55°	22	1006036
3000K	3550lm	20°	22	1006048
	3550lm	40°	22	1006051
	3550lm	55°	22	1006054
4000K	3800lm	20°	22	1006066
	3800lm	40°	22	1006069
	3800lm	55°	22	1006072
2700K	3400lm	20°	22	1006031
	3400lm	40°	22	1006034
	3400lm	55°	22	1006037
3000K	3500lm	20°	22	1006049
	3500lm	40°	22	1006052
	3500lm	55°	22	1006055
4000K	3750lm	20°	22	1006067
	3750lm	40°	22	1006070
	3750lm	55°	22	1006073
2700K	3300lm	20°	22	1006038
	3300lm	40°	22	1006041
	3300lm	55°	22	1006044
3000K	3300lm	20°	22	1006056
	3300lm	40°	22	1006059
	3300lm	55°	22	1006062
4000K	3600lm	20°	22	1006074
	3600lm	40°	22	1006077
	3600lm	55°	22	1006080
2700K	3500lm	20°	22	1006039
	3500lm	40°	22	1006042
	3500lm	55°	22	1006045
3000K	3550lm	20°	22	1006057
	3550lm	40°	22	1006060
	3550lm	55°	22	1006063
4000K	3800lm	20°	22	1006075
	3800lm	40°	22	1006078
	3800lm	55°	22	1006081
2700K	3400lm	20°	22	1006040
	3400lm	40°	22	1006043
	3400lm	55°	22	1006046
3000K	3500lm	20°	22	1006058
	3500lm	40°	22	1006061
	3500lm	55°	22	1006064
4000K	3750lm	20°	22	1006076
	3750lm	40°	22	1006079
	3750lm	55°	22	1006082



ZUBEHÖR

Perfekte Treiberzuordnung

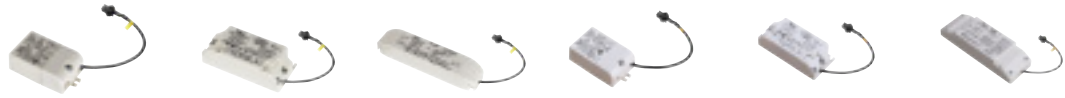

LED Treiber
200mA, 10W QC

LED Treiber
200mA, 10W,
PHASE QC

LED Treiber
200mA, 30W,
DALI QC

LED Treiber
250mA, 10W

LED Treiber
250mA, 10W,
PHASE

LED Treiber
250mA, 20W,
DALI

XS

XS

XS

S

S

S

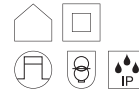
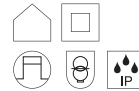
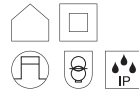
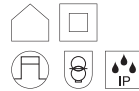
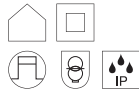

200mA

200mA

200mA

250mA

250mA

250/350/500/700mA

Material	Polycarbonat (PC)	Polycarbonat (PC)	Polycarbonat (PC)	Polycarbonat (PC)	Polycarbonat (PC)	Polycarbonat (PC)
Farbe	weiß	weiß	weiß	weiß	weiß	weiß
Spannung prim.	200-240V ~50/60Hz	200-240V ~50/60Hz	200-240V ~50/60Hz	220-240V ~50/60Hz	220-240V ~50/60Hz	220-240V ~50/60Hz
Spannung sek.	29-42V DC	30-42V DC	15-54V DC	26-40V	30-42V	6-60V
Ausgangsstrom	200mA	200mA	200mA	250mA	250mA	250mA
Anzahl Ausgänge sek.	1	1	1	1	1	1
Leistung von	5,8W	6W	3,8W	6,5W	7,5W	1,5W
Leistung bis	8,4W	8,4W	13,5W	10W	10W	15W
Umgebungstemp. min.	-	-	-	-20°C	-20°C	-20°C
Umgebungstemp. max.	-	-	-	45°C	50°C	50°C
Temperaturschutz	110°C	110°C	110°C	110°C	110°C	110°C
IP-Schutzart	IP 20	IP 20	IP 20	IP 20	IP 20	IP 20
Dimmbar	-	PHASE C	DALI	-	PHASE C	DALI
Länge	6,5 cm	8,5 cm	18 cm	6,5 cm	8,5 cm	15 cm
Breite	3,9 cm	4,1 cm	4,5 cm	3,9 cm	3,9 cm	5,2 cm
Höhe	3,5 cm	3 cm	3 cm	2 cm	2,2 cm	2,8 cm
Art. Nr.	1005610	1005609	1005611	1004058	1004055	1004067

Diffusoren

XS

S



Diffusor
elliptisch

Diffusor
prismatisch

Diffusor
gefrostet

Diffusor
Wabe

Diffusor
elliptisch

Diffusor
prismatisch

Diffusor
gefrostet

Diffusor
Wabe

Art. Nr.	1005612	1005613	1005614	1005615	1004786	1004787	1004788	1004789
-----------------	----------------	----------------	----------------	----------------	----------------	----------------	----------------	----------------

ZUBEHÖR



LED Treiber
500mA, 30W



LED Treiber
500mA, 30W,
PHASE



LED Treiber
500mA, 40W,
DALI

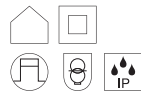
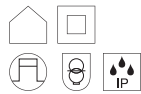

500/600/700mA

500mA

500/700/1050mA

Material	Polycarbonat (PC)	Polycarbonat (PC)	Polycarbonat (PC)
Farbe	weiß	weiß	weiß
Spannung prim.	220-240V ~50/60Hz	220-240V ~50/60Hz	220-240V ~50/60Hz
Spannung sek.	30-42V	25-42V	6-58V
Ausgangsstrom	500mA	500mA	500mA
Anzahl Ausgänge sek.	1	1	1
Leistung von	15W	12,5W	1,5W
Leistung bis	29,5W	21W	40,6W
Umgebungstemp. min.	-20°C	-25°C	-25°C
Umgebungstemp. max.	50°C	50°C	50°C
Temperaturschutz	110°C	110°C	110°C
IP-Schutzart	IP 20	IP 20	IP 20
Dimmbar	-	PHASE C	DALI
Länge	14,7 cm	11,5 cm	12,3 cm
Breite	4,3 cm	4,1 cm	7,9 cm
Höhe	3 cm	2,5 cm	2,4 cm
Art. Nr.	1004064	1004054	1004069



Diffusor
elliptisch



Diffusor
prismatisch



Diffusor
gefrostet



Diffusor
Wabe

Art. Nr.	1004790	1004791	1004792	1004793
-----------------	----------------	----------------	----------------	----------------

ZUBEHÖR

Perfekte Treiberzuordnung



LED Treiber
1050mA, 40W



LED Treiber
700mA, 30W,
PHASE



LED Treiber
700mA, 40W, DALI



LED Treiber
1050mA, 40W



LED Treiber
1000mA, 40W,
PHASE



LED Treiber
1050mA, 50W,
DALI

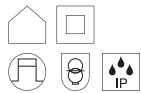

500/600/700mA

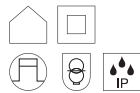

700mA

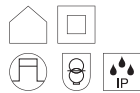

700mA

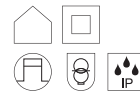

800/900/1050mA

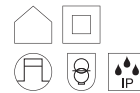

1000mA

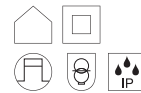

1050mA

Material	Polycarbonat (PC)	Polycarbonat (PC)	Polycarbonat (PC)	Polycarbonat (PC)	Polycarbonat (PC)	Polycarbonat (PC)
Farbe	weiß	weiß	weiß	weiß	weiß	weiß
Spannung prim.	220-240V ~50/60Hz	220-240V ~50/60Hz	220-240V ~50/60Hz	220-240V ~50/60Hz	220-240V ~50/60Hz	220-240V ~50/60Hz
Spannung sek.	30-42V	30-42V	6-58V	30-42V	25-40V	6-58V
Ausgangsstrom	700mA	700mA	250/350/500/700mA	1050mA	1050mA	1050mA
Anzahl Ausgänge sek.	1	1	1	1	1	1
Leistung von	15W	21W	1,5W	24W	26,3W	4,2W
Leistung bis	29,5W	29,4W	40,6W	44W	42W	50W
Umgebungstemp. min.	-20°C	-20°C	-25°C	-20°C	-20°C	-25°C
Umgebungstemp. max.	50°C	50°C	50°C	50°C	50°C	50°C
Temperaturschutz	110°C	110°C	110°C	110°C	110°C	110°C
IP-Schutzart	IP 20	IP 20	IP 20	IP 20	IP 20	IP 20
Dimmbar	-	PHASE C	DALI	-	PHASE C	DALI
Länge	14,7 cm	11,5 cm	12,3 cm	9,7 cm	14,5 cm	12,3 cm
Breite	4,3 cm	4,4 cm	7,9 cm	4,3 cm	4 cm	7,9 cm
Höhe	3 cm	3 cm	2,4 cm	3 cm	3 cm	2,4 cm
Art. Nr.	1004062	1004065	1004070	1004059	1004066	1004071

Diffusoren



Diffusor
elliptisch



Diffusor
prismatisch



Diffusor
gefrostet



Diffusor
Wabe



Diffusor
elliptisch



Diffusor
prismatisch



Diffusor
gefrostet



Diffusor
Wabe

Art. Nr.	1004794	1004795	1004796	1004797	1004798	1004799	1004800	1004801
----------	---------	---------	---------	---------	---------	---------	---------	---------

ZEIT FÜR VERÄNDERUNG. ZEIT FÜR EIN UPDATE.

Eine veraltete, oft noch mit konventionellen Leuchtmitteln ausgestattete Deckeneinbauleuchte soll einer energieeffizienten und kostensparenden Alternative weichen. Bei der Demontage finden Sie dabei häufig einen größeren Deckenausschnitt vor als benötigt.

Hier bietet SLV die passende Lösung: unsere neuen Reduzierringe.

Die Reduzierringe decken den größeren Deckenausschnitt komplett ab und geben gleichzeitig Ihrer neuen, kompakten Deckeneinbauleuchte perfekten Halt.

Sauber, zeitsparend, unkompliziert.

Und dabei perfekt abgestimmt auf das SLV NUMINOS® Down – und Spotlightsystem.



1. Die alte Leuchte hat einen größeren Durchmesser, als die Neue? Kein Problem!



2. Deinstallieren Sie die alte Deckeneinbauleuchte.



3. Setzen Sie einen der neuen Leuchte angepassten Reduzierring ein.



4. Durch den Reduzierring haben Sie den vergrößerten Deckenausschnitt gänzlich abgedeckt.



5. Nun können Sie den elektrischen Anschluss und die Installation der neuen Deckeneinbauleuchte abschließen.



6. Dank des Reduzierings ist der größere Deckenausschnitt nun nicht mehr sichtbar.

Reduzierring rund

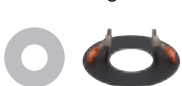

Material	Stahl	Stahl	Stahl	Stahl	Stahl
Außen-Ø	16 cm	16 cm	24 cm	24 cm	24 cm
Höhe	5,3 cm	5,3 cm	5,3 cm	5,3 cm	5,3 cm
Innen-Ø	7 cm	9 cm	12 cm	15 cm	18 cm
Deckenausschnitt	8,5 - 13 cm	12 - 15 cm	14 - 18 cm	17 - 20 cm	20 - 22 cm
Materialdicke	3 cm	3 cm	3 cm	3 cm	3 cm
Art. Nr. schwarz	1006135	1006139	1006143	1006147	1006151
Art. Nr. weiß	1006136	1006140	1006144	1006148	1006152

Reduzierring eckig



Material	Stahl	Stahl	Stahl	Stahl	Stahl
Länge	16 cm	16 cm	24 cm	24 cm	24 cm
Breite	16 cm	16 cm	24 cm	24 cm	24 cm
Höhe	5,3 cm	5,3 cm	5,3 cm	5,3 cm	5,3 cm
Innen-Ø	7 cm	9 cm	12 cm	15 cm	18 cm
Deckenausschnitt	8,5 - 13 cm	12 - 15 cm	14 - 18 cm	17 - 20 cm	20 - 22 cm
Materialdicke	3 cm	3 cm	3 cm	3 cm	3 cm
Art. Nr. schwarz	1006137	1006141	1006145	1006149	1006153
Art. Nr. weiß	1006138	1006142	1006146	1006150	1006154

SLV NUMINOS® S



3Ph.

Produktangaben:

220-240V ~50/60Hz | 250mA

Systemleistung: 11W

Material: Aluminium / Polycarbonat (PC)

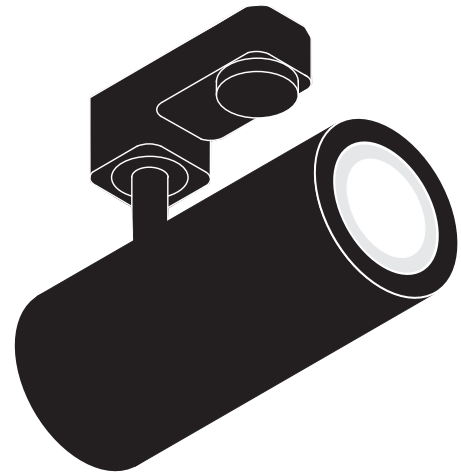
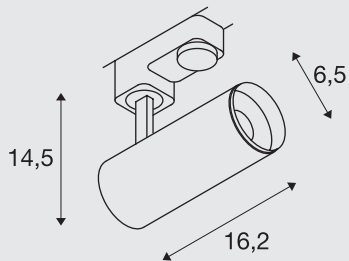

■ schwarz

Hinweis:

Zierring auch in Weiß erhältlich



Zierring S ■ weiß Art. Nr. 1006167

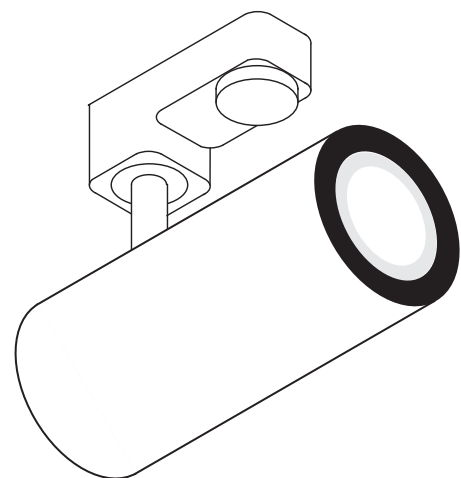

□ weiß



ART. NR.



	985lm	24°	16	1004074
2700K	985lm	36°	16	1004075
	980lm	60°	19	1004076
	1020lm	24°	13	1004082
3000K	1020lm	36°	13	1004083
	1020lm	60°	19	1004084
	1100lm	24°	16	1004090
4000K	1100lm	36°	16	1004091
	1100lm	60°	19	1004092



	985lm	24°	16	1004362
2700K	985lm	36°	16	1004363
	980lm	60°	19	1004364
	1020lm	24°	13	1004370
3000K	1020lm	36°	13	1004371
	1020lm	60°	19	1004372
	1100lm	24°	16	1004378
4000K	1100lm	36°	16	1004379
	1100lm	60°	19	1004380



	985lm	24°	16	1004078
2700K	985lm	36°	16	1004079
	980lm	60°	19	1004080
	1020lm	24°	13	1004086
3000K	1020lm	36°	13	1004087
	1020lm	60°	19	1004088
	1100lm	24°	16	1004094
4000K	1100lm	36°	16	1004095
	1100lm	60°	19	1004096



	985lm	24°	16	1004366
2700K	985lm	36°	16	1004367
	980lm	60°	19	1004368
	1020lm	24°	13	1004374
3000K	1020lm	36°	13	1004375
	1020lm	60°	19	1004376
	1100lm	24°	16	1004382
4000K	1100lm	36°	16	1004383
	1100lm	60°	19	1004384



SLV NUMINOS® M



3Ph.

Produktangaben:

220-240V ~50/60Hz | 500mA

Systemleistung: 20W

Material: Aluminium / Polycarbonat (PC)

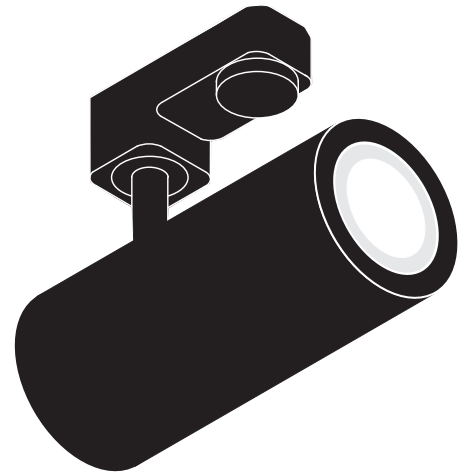
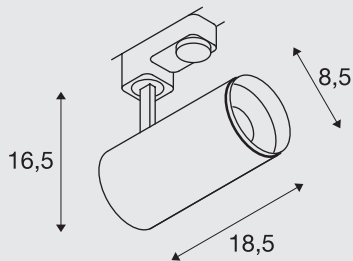

■ schwarz

Hinweis:

Zierring auch in Weiß erhältlich



Zierring M

■ weiß

Art. Nr. 1006168

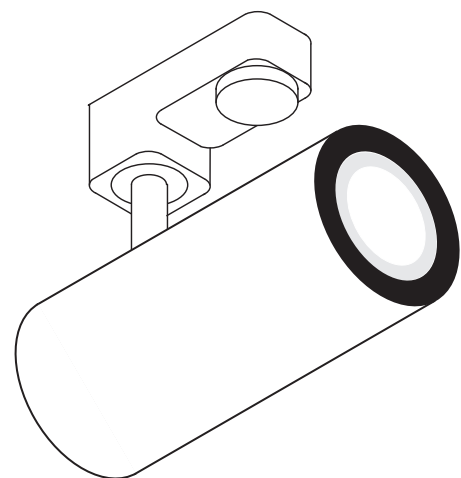

□ weiß



ART. NR.



	1925lm	24°	16	1004170
2700K	1935lm	36°	16	1004171
	1885lm	60°	22	1004172
	1955lm	24°	16	1004178
3000K	1970lm	36°	13	1004179
	1880lm	60°	22	1004180
	2125lm	24°	19	1004186
4000K	2120lm	36°	16	1004187
	2060lm	60°	25	1004188



	1925lm	24°	16	1004458
2700K	1935lm	36°	16	1004459
	1885lm	60°	22	1004460
	1955lm	24°	16	1004466
3000K	1970lm	36°	13	1004467
	1880lm	60°	22	1004468
	2125lm	24°	19	1004474
4000K	2120lm	36°	16	1004475
	2060lm	60°	25	1004476



	1925lm	24°	16	1004174
2700K	1935lm	36°	16	1004175
	1885lm	60°	22	1004176
	1955lm	24°	16	1004182
3000K	1970lm	36°	13	1004183
	1880lm	60°	22	1004184
	2125lm	24°	19	1004190
4000K	2120lm	36°	16	1004191
	2060lm	60°	25	1004192



	1925lm	24°	16	1004462
2700K	1935lm	36°	16	1004463
	1885lm	60°	22	1004464
	1955lm	24°	16	1004470
3000K	1970lm	36°	13	1004471
	1880lm	60°	22	1004472
	2125lm	24°	19	1004478
4000K	2120lm	36°	16	1004479
	2060lm	60°	25	1004480



SLV NUMINOS® L



3Ph.

Produktangaben:

220-240V ~50/60Hz | 700mA

Systemleistung: 28W

Material: Aluminium / Polycarbonat (PC)

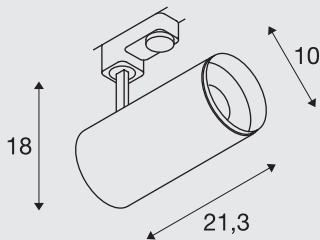

Hinweis:

Zierring auch in Weiß erhältlich

Zierring L

■ weiß

Art. Nr. 1006169

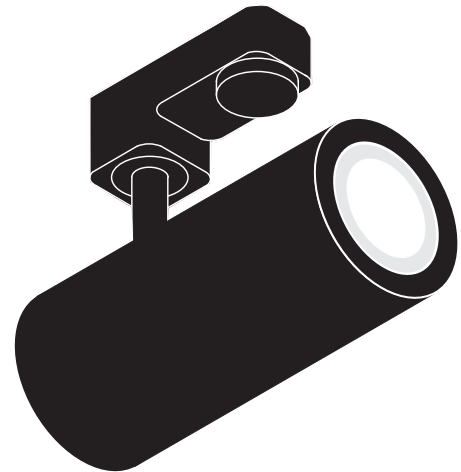

■ schwarz

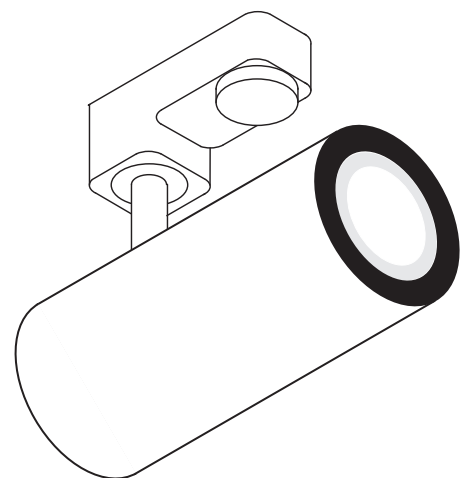

□ weiß



ART. NR.



	2440lm	24°	19	1004266
2700K	2400lm	36°	19	1004267
	2475lm	60°	22	1004268
	2430lm	24°	13	1004274
3000K	2340lm	36°	13	1004275
	2400lm	60°	22	1004276
	2675lm	24°	19	1004282
4000K	2620lm	36°	19	1004283
	2715lm	60°	22	1004284



	2440lm	24°	19	1004554
2700K	2400lm	36°	19	1004555
	2475lm	60°	22	1004556
	2430lm	24°	13	1004562
3000K	2340lm	36°	13	1004563
	2400lm	60°	22	1004564
	2675lm	24°	19	1004570
4000K	2620lm	36°	19	1004571
	2715lm	60°	22	1004572



	2440lm	24°	19	1004270
2700K	2400lm	36°	19	1004271
	2475lm	60°	22	1004272
	2430lm	24°	13	1004278
3000K	2340lm	36°	13	1004279
	2400lm	60°	22	1004280
	2675lm	24°	19	1004286
4000K	2620lm	36°	19	1004287
	2715lm	60°	22	1004288



	2440lm	24°	19	1004558
2700K	2400lm	36°	19	1004559
	2475lm	60°	22	1004560
	2430lm	24°	13	1004566
3000K	2340lm	36°	13	1004567
	2400lm	60°	22	1004568
	2675lm	24°	19	1004574
4000K	2620lm	36°	19	1004575
	2715lm	60°	22	1004576



SLV NUMINOS® XL



3Ph.

Produktangaben:

220-240V ~50/60Hz | 900mA

Systemleistung: 36W

Material: Aluminium / Polycarbonat (PC)

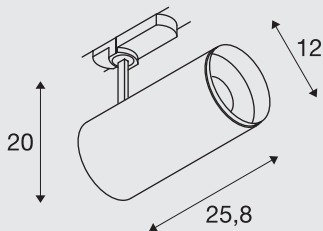

Hinweis:

Zierring auch in Weiß erhältlich

Zierring XL

■ weiß

Art. Nr. 1006170

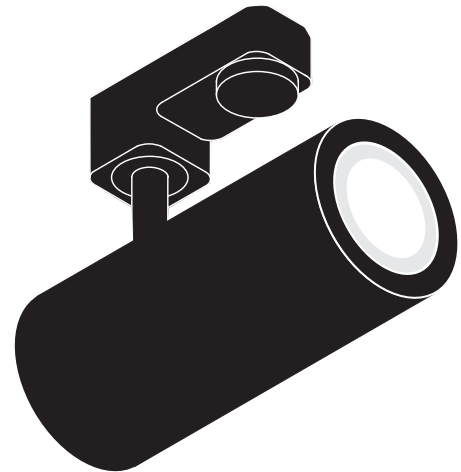

■ schwarz

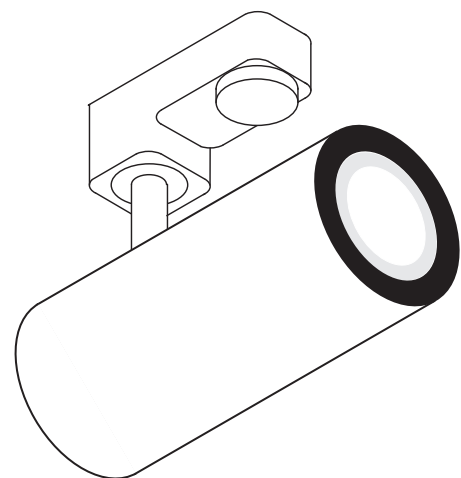

□ weiß



ART. NR.



		3290lm	24°	19	1005723
2700K		3250lm	36°	19	1005724
		2980lm	60°	25	1005725
		3530lm	24°	19	1005729
3000K		3490lm	36°	19	1005730
		3210lm	60°	25	1005731
		3800lm	24°	19	1005735
4000K		3760lm	36°	19	1005736
		3460lm	60°	25	1005737



		3290lm	24°	19	1005795
2700K		3250lm	36°	19	1005796
		2980lm	60°	25	1005797
		3530lm	24°	19	1005801
3000K		3490lm	36°	19	1005802
		3210lm	60°	25	1005803
		3800lm	24°	19	1005807
4000K		3760lm	36°	19	1005808
		3460lm	60°	25	1005809



		3290lm	24°	19	1005726
2700K		3250lm	36°	19	1005727
		2980lm	60°	25	1005728
		3530lm	24°	19	1005732
3000K		3490lm	36°	19	1005733
		3210lm	60°	25	1005734
		3800lm	24°	19	1005738
4000K		3760lm	36°	19	1005739
		3460lm	60°	25	1005740



		3290lm	24°	19	1005798
2700K		3250lm	36°	19	1005799
		2980lm	60°	25	1005800
		3530lm	24°	19	1005804
3000K		3490lm	36°	19	1005805
		3210lm	60°	25	1005806
		3800lm	24°	19	1005810
4000K		3760lm	36°	19	1005811
		3460lm	60°	25	1005812



SLV NUMINOS® ZOOM M

3Ph.



Produktangaben:

220-240V ~50/60Hz | 500mA

Systemleistung: 20W

Material: Aluminium / Polycarbonat (PC)

- Halbstreuwinkel einstellbar von 15°-60°.

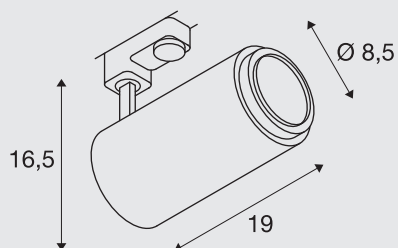
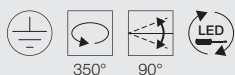

Hinweis:

Zierring auch in Weiß erhältlich

Zierring M

■ weiß

Art. Nr. 1006168

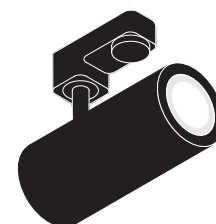

■ schwarz

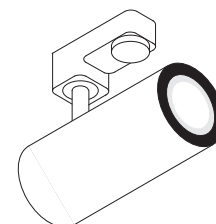

□ weiß





ART. NR.



2700K	680-1650lm	15°-60°	25	1006108
3000K	750-1800lm	15°-60°	25	1006110
4000K	780-1900lm	15°-60°	25	1006112



2700K	680-1650lm	15°-60°	25	1006114
3000K	750-1800lm	15°-60°	25	1006116
4000K	780-1900lm	15°-60°	25	1006118



2700K	680-1650lm	15°-60°	25	1006109
3000K	750-1800lm	15°-60°	25	1006111
4000K	780-1900lm	15°-60°	25	1006113



2700K	680-1650lm	15°-60°	25	1006115
3000K	750-1800lm	15°-60°	25	1006117
4000K	780-1900lm	15°-60°	25	1006119



SLV NUMINOS® S



CW

Produktangaben:

220-240V ~50/60Hz | 250mA

Systemleistung: 11W

Material: Aluminium / Polycarbonat (PC)

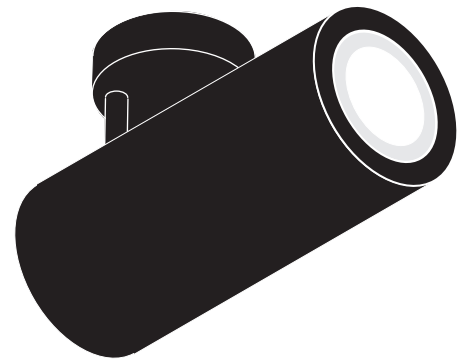
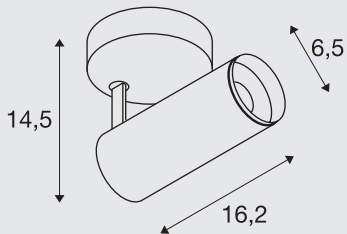

■ schwarz

Hinweis:

Zierring auch in Weiß erhältlich



Zierring S

■ weiß

Art. Nr. 1006167

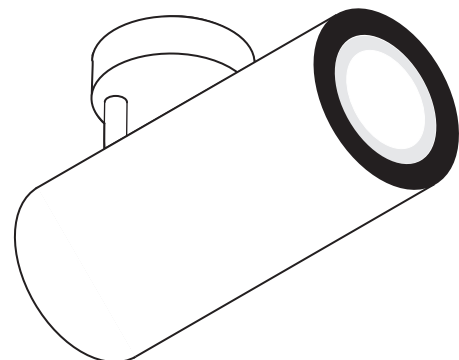

□ weiß



ART. NR.



	985lm	24°	16	1004098
2700K	985lm	36°	16	1004099
	980lm	60°	19	1004100
	1020lm	24°	13	1004106
3000K	1020lm	36°	13	1004107
	1020lm	60°	19	1004108
	1100lm	24°	16	1004114
4000K	1100lm	36°	16	1004115
	1100lm	60°	19	1004116



	985lm	24°	16	1004386
2700K	985lm	36°	16	1004387
	980lm	60°	19	1004388
	1020lm	24°	13	1004394
3000K	1020lm	36°	13	1004395
	1020lm	60°	19	1004396
	1100lm	24°	16	1004402
4000K	1100lm	36°	16	1004403
	1100lm	60°	19	1004404



	985lm	24°	16	1004102
2700K	985lm	36°	16	1004103
	980lm	60°	19	1004104
	1020lm	24°	13	1004110
3000K	1020lm	36°	13	1004111
	1020lm	60°	19	1004112
	1100lm	24°	16	1004118
4000K	1100lm	36°	16	1004119
	1100lm	60°	19	1004120



	985lm	24°	16	1004390
2700K	985lm	36°	16	1004391
	980lm	60°	19	1004392
	1020lm	24°	13	1004398
3000K	1020lm	36°	13	1004399
	1020lm	60°	19	1004400
	1100lm	24°	16	1004406
4000K	1100lm	36°	16	1004407
	1100lm	60°	19	1004408



SLV NUMINOS® M



CL

Produktangaben:

220-240V ~50/60Hz | 500mA

Systemleistung: 20W

Material: Aluminium / Polycarbonat (PC)

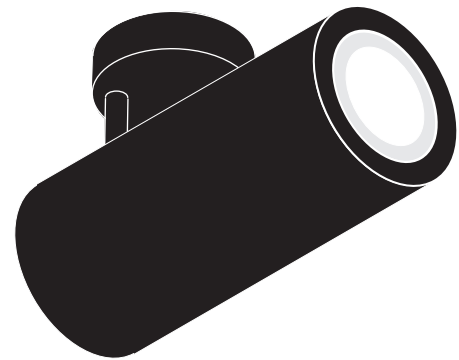
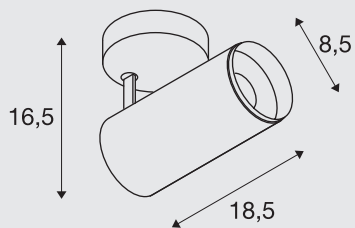

■ schwarz

Hinweis:

Zierring auch in Weiß erhältlich



Zierring M

■ weiß

Art. Nr. 1006168

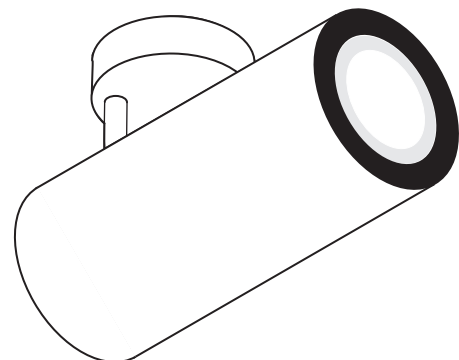

□ weiß



ART. NR.



	1925lm	24°	16	1004194
2700K	1935lm	36°	16	1004195
	1885lm	60°	22	1004196
	1955lm	24°	16	1004202
3000K	1970lm	36°	13	1004203
	1880lm	60°	22	1004204
	2125lm	24°	19	1004210
4000K	2120lm	36°	16	1004211
	2060lm	60°	25	1004212



	1925lm	24°	16	1004482
2700K	1935lm	36°	16	1004483
	1885lm	60°	22	1004484
	1955lm	24°	16	1004490
3000K	1970lm	36°	13	1004491
	1880lm	60°	22	1004492
	2125lm	24°	19	1004498
4000K	2120lm	36°	16	1004499
	2060lm	60°	25	1004500



	1925lm	24°	16	1004198
2700K	1935lm	36°	16	1004199
	1885lm	60°	22	1004200
	1955lm	24°	16	1004206
3000K	1970lm	36°	13	1004207
	1880lm	60°	22	1004208
	2125lm	24°	19	1004214
4000K	2120lm	36°	16	1004215
	2060lm	60°	25	1004216



	1925lm	24°	16	1004486
2700K	1935lm	36°	16	1004487
	1885lm	60°	22	1004488
	1955lm	24°	16	1004494
3000K	1970lm	36°	13	1004495
	1880lm	60°	22	1004496
	2125lm	24°	19	1004502
4000K	2120lm	36°	16	1004503
	2060lm	60°	25	1004504



SLV NUMINOS® L



CL

Produktangaben:

220-240V ~50/60Hz | 700mA

Systemleistung: 28W

Material: Aluminium / Polycarbonat (PC)

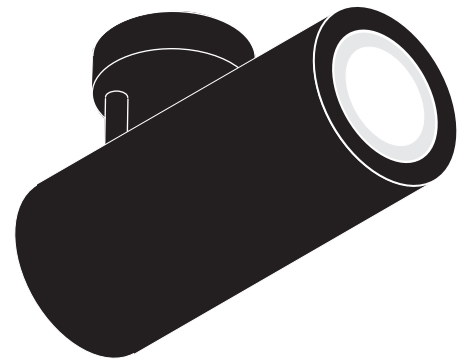
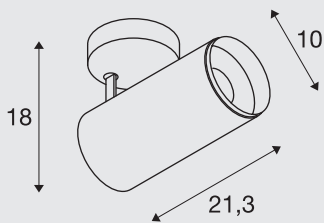

■ schwarz

Hinweis:

Zierring auch in Weiß erhältlich



Zierring L

■ weiß

Art. Nr. 1006169

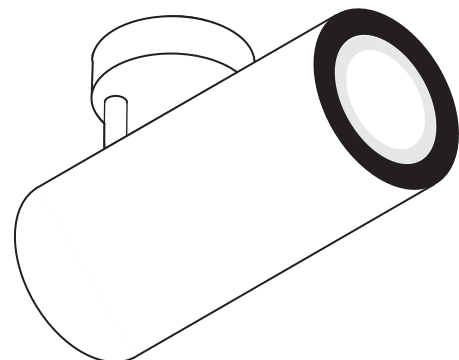

□ weiß



ART. NR.



	2440lm	24°	19	1004290
2700K	2400lm	36°	19	1004291
	2475lm	60°	22	1004292
	2430lm	24°	13	1004298
3000K	2340lm	36°	13	1004299
	2400lm	60°	22	1004300
	2675lm	24°	19	1004306
4000K	2620lm	36°	19	1004307
	2715lm	60°	22	1004308



	2440lm	24°	19	1004578
2700K	2400lm	36°	19	1004579
	2475lm	60°	22	1004580
	2430lm	24°	13	1004586
3000K	2340lm	36°	13	1004587
	2400lm	60°	22	1004588
	2675lm	24°	19	1004594
4000K	2620lm	36°	19	1004595
	2715lm	60°	22	1004596



	2440lm	24°	19	1004294
2700K	2400lm	36°	19	1004295
	2475lm	60°	22	1004296
	2430lm	24°	13	1004302
3000K	2340lm	36°	13	1004303
	2400lm	60°	22	1004304
	2675lm	24°	19	1004310
4000K	2620lm	36°	19	1004311
	2715lm	60°	22	1004312



	2440lm	24°	19	1004582
2700K	2400lm	36°	19	1004583
	2475lm	60°	22	1004584
	2430lm	24°	13	1004590
3000K	2340lm	36°	13	1004591
	2400lm	60°	22	1004592
	2675lm	24°	19	1004598
4000K	2620lm	36°	19	1004599
	2715lm	60°	22	1004600



SLV NUMINOS® XL



CL

Produktangaben:

220-240V ~50/60Hz | 900mA

Systemleistung: 36W

Material: Aluminium / Polycarbonat (PC)

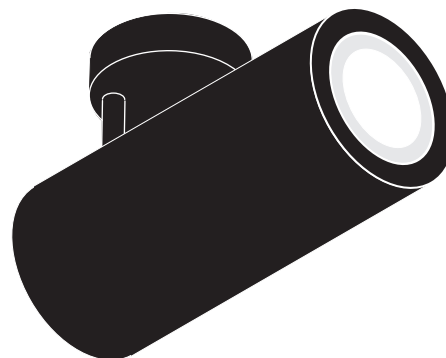
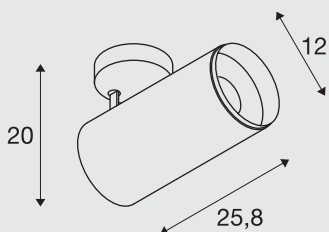

■ schwarz

Hinweis:

Zierring auch in Weiß erhältlich



Zierring XL

■ weiß

Art. Nr. 1006170

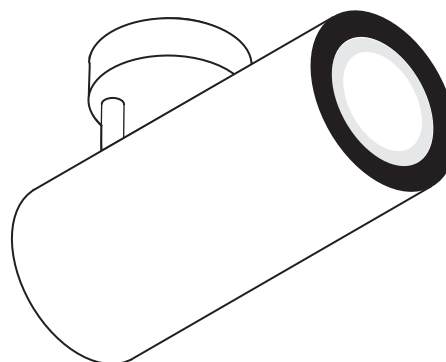

□ weiß



ART. NR.



	3290lm	24°	19	1006083
2700K	3250lm	36°	19	1006084
	2980lm	60°	25	1006085
	3530lm	24°	19	1006089
3000K	3490lm	36°	19	1006090
	3210lm	60°	25	1006091
	3800lm	24°	19	1006095
4000K	3760lm	36°	19	1006096
	3460lm	60°	25	1006097



	3290lm	24°	19	1005741
2700K	3250lm	36°	19	1005742
	2980lm	60°	25	1005743
	3530lm	24°	19	1005747
3000K	3490lm	36°	19	1005748
	3210lm	60°	25	1005749
	3800lm	24°	19	1005753
4000K	3760lm	36°	19	1005754
	3460lm	60°	25	1005755



	3290lm	24°	19	1006086
2700K	3250lm	36°	19	1006087
	2980lm	60°	25	1006088
	3530lm	24°	19	1006092
3000K	3490lm	36°	19	1006093
	3210lm	60°	25	1006094
	3800lm	24°	19	1006098
4000K	3760lm	36°	19	1006099
	3460lm	60°	25	1006100



	3290lm	24°	19	1005744
2700K	3250lm	36°	19	1005745
	2980lm	60°	25	1005746
	3530lm	24°	19	1005750
3000K	3490lm	36°	19	1005751
	3210lm	60°	25	1005752
	3800lm	24°	19	1005756
4000K	3760lm	36°	19	1005757
	3460lm	60°	25	1005758



SLV NUMINOS® S



CL

Produktangaben:

220-240V ~50/60Hz | 250mA

Systemleistung: 11W

Material: Aluminium / Polycarbonat (PC)

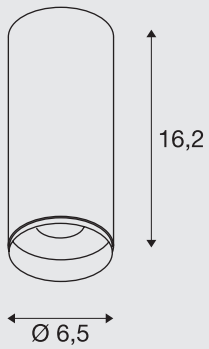

Hinweis:

Zierring auch in Weiß erhältlich

Zierring S

■ weiß

Art. Nr. 1006167



■ schwarz

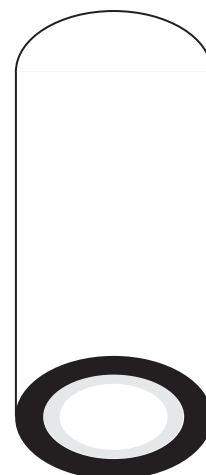

□ weiß



ART. NR.



	985lm	24°	16	1004122
2700K	985lm	36°	16	1004123
	980lm	60°	19	1004124
3000K	1020lm	24°	13	1004130
	1020lm	36°	13	1004131
	1020lm	60°	19	1004132
4000K	1100lm	24°	16	1004138
	1100lm	36°	16	1004139
	1100lm	60°	19	1004140



	985lm	24°	16	1004410
2700K	985lm	36°	16	1004411
	980lm	60°	19	1004412
3000K	1020lm	24°	13	1004418
	1020lm	36°	13	1004419
	1020lm	60°	19	1004420
4000K	1100lm	24°	16	1004426
	1100lm	36°	16	1004427
	1100lm	60°	19	1004428



	985lm	24°	16	1004126
2700K	985lm	36°	16	1004127
	980lm	60°	19	1004128
3000K	1020lm	24°	13	1004134
	1020lm	36°	13	1004135
	1020lm	60°	19	1004136
4000K	1100lm	24°	16	1004142
	1100lm	36°	16	1004143
	1100lm	60°	19	1004144



	985lm	24°	16	1004414
2700K	985lm	36°	16	1004415
	980lm	60°	19	1004416
3000K	1020lm	24°	13	1004422
	1020lm	36°	13	1004423
	1020lm	60°	19	1004424
4000K	1100lm	24°	16	1004430
	1100lm	36°	16	1004431
	1100lm	60°	19	1004432



SLV NUMINOS® M



CL

Produktangaben:

220-240V ~50/60Hz | 500mA

Systemleistung: 20W

Material: Aluminium / Polycarbonat (PC)

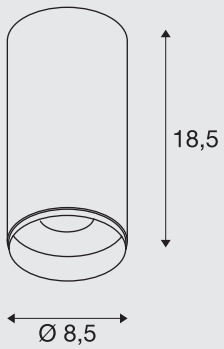

Hinweis:

Zierring auch in Weiß erhältlich

Zierring M

■ weiß

Art. Nr. 1006168



■ schwarz

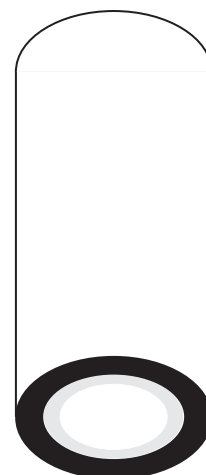

□ weiß



ART. NR.



	1925lm	24°	16	1004218
2700K	1935lm	36°	16	1004219
	1885lm	60°	22	1004220
	1955lm	24°	16	1004226
3000K	1970lm	36°	13	1004227
	1880lm	60°	22	1004228
	2125lm	24°	19	1004234
4000K	2120lm	36°	16	1004235
	2060lm	60°	25	1004236



	1925lm	24°	16	1004506
2700K	1935lm	36°	16	1004507
	1885lm	60°	22	1004508
	1955lm	24°	16	1004514
3000K	1970lm	36°	13	1004515
	1880lm	60°	22	1004516
	2125lm	24°	19	1004522
4000K	2120lm	36°	16	1004523
	2060lm	60°	25	1004524



	1925lm	24°	16	1004222
2700K	1935lm	36°	16	1004223
	1885lm	60°	22	1004224
	1955lm	24°	16	1004230
3000K	1970lm	36°	13	1004231
	1880lm	60°	22	1004232
	2125lm	24°	19	1004238
4000K	2120lm	36°	16	1004239
	2060lm	60°	25	1004240



	1925lm	24°	16	1004510
2700K	1935lm	36°	16	1004511
	1885lm	60°	22	1004512
	1955lm	24°	16	1004518
3000K	1970lm	36°	13	1004519
	1880lm	60°	22	1004520
	2125lm	24°	19	1004526
4000K	2120lm	36°	16	1004527
	2060lm	60°	25	1004528



SLV NUMINOS® L



CL

Produktangaben:

220-240V ~50/60Hz | 700mA

Systemleistung: 28W

Material: Aluminium / Polycarbonat (PC)

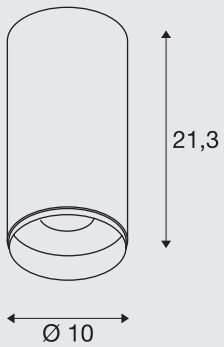

Hinweis:

Zierring auch in Weiß erhältlich

Zierring L

■ weiß

Art. Nr. 1006169



■ schwarz

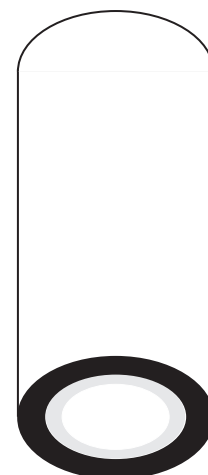

□ weiß



ART. NR.



	2440lm	24°	19	1004314
2700K	2400lm	36°	19	1004315
	2475lm	60°	22	1004316
	2430lm	24°	13	1004322
3000K	2340lm	36°	13	1004323
	2400lm	60°	22	1004324
	2675lm	24°	19	1004330
4000K	2620lm	36°	19	1004331
	2715lm	60°	22	1004332



	2440lm	24°	19	1004602
2700K	2400lm	36°	19	1004603
	2475lm	60°	22	1004604
	2430lm	24°	13	1004610
3000K	2340lm	36°	13	1004611
	2400lm	60°	22	1004612
	2675lm	24°	19	1004618
4000K	2620lm	36°	19	1004619
	2715lm	60°	22	1004620



	2440lm	24°	19	1004318
2700K	2400lm	36°	19	1004319
	2475lm	60°	22	1004320
	2430lm	24°	13	1004326
3000K	2340lm	36°	13	1004327
	2400lm	60°	22	1004328
	2675lm	24°	19	1004334
4000K	2620lm	36°	19	1004335
	2715lm	60°	22	1004336



	2440lm	24°	19	1004606
2700K	2400lm	36°	19	1004607
	2475lm	60°	22	1004608
	2430lm	24°	13	1004614
3000K	2340lm	36°	13	1004615
	2400lm	60°	22	1004616
	2675lm	24°	19	1004622
4000K	2620lm	36°	19	1004623
	2715lm	60°	22	1004624



SLV NUMINOS® XL



CL

Produktangaben:

220-240V ~50/60Hz | 900mA

Systemleistung: 36W

Material: Aluminium / Polycarbonat (PC)

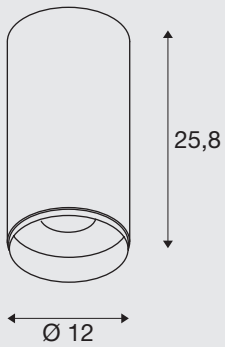

Hinweis:

Zierring auch in Weiß erhältlich

Zierring XL

■ weiß

Art. Nr. 1006170



■ schwarz

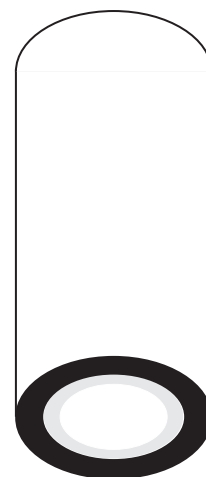

□ weiß



ART. NR.



	3290lm	24°	19	1005687
2700K	3250lm	36°	19	1005688
	2980lm	60°	25	1005689
	3530lm	24°	19	1005693
3000K	3490lm	36°	19	1005694
	3210lm	60°	25	1005695
4000K	3800lm	24°	19	1005699
	3760lm	36°	19	1005700
	3460lm	60°	25	1005701



	3290lm	24°	19	1005759
2700K	3250lm	36°	19	1005760
	2980lm	60°	25	1005761
3000K	3530lm	24°	19	1005765
	3490lm	36°	19	1005766
	3210lm	60°	25	1005767
4000K	3800lm	24°	19	1005771
	3760lm	36°	19	1005772
	3460lm	60°	25	1005773



	3290lm	24°	19	1005690
2700K	3250lm	36°	19	1005691
	2980lm	60°	25	1005692
	3530lm	24°	19	1005696
3000K	3490lm	36°	19	1005697
	3210lm	60°	25	1005698
4000K	3800lm	24°	19	1005702
	3760lm	36°	19	1005703
	3460lm	60°	25	1005704



	3290lm	24°	19	1005762
2700K	3250lm	36°	19	1005763
	2980lm	60°	25	1005764
	3530lm	24°	19	1005768
3000K	3490lm	36°	19	1005769
	3210lm	60°	25	1005770
4000K	3800lm	24°	19	1005774
	3760lm	36°	19	1005775
	3460lm	60°	25	1005776



SLV NUMINOS® S



PD

Produktangaben:

220-240V ~50/60Hz | 250mA

Systemleistung: 11W

Material: Aluminium / Polycarbonat (PC)

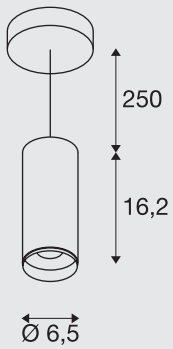
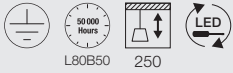

Hinweis:

Zierring auch in Weiß erhältlich

Zierring S

■ weiß

Art. Nr. 1006167



■ schwarz

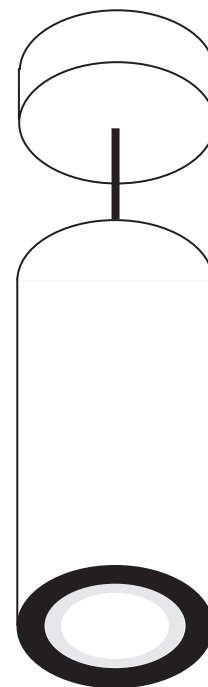

□ weiß



ART. NR.



	985lm	24°	16	1004146
2700K	985lm	36°	16	1004147
	980lm	60°	19	1004148
	1020lm	24°	13	1004154
3000K	1020lm	36°	13	1004155
	1020lm	60°	19	1004156
	1100lm	24°	16	1004162
4000K	1100lm	36°	16	1004163
	1100lm	60°	19	1004164



	985lm	24°	16	1004434
2700K	985lm	36°	16	1004435
	980lm	60°	19	1004436
	1020lm	24°	13	1004442
3000K	1020lm	36°	13	1004443
	1020lm	60°	19	1004444
	1100lm	24°	16	1004450
4000K	1100lm	36°	16	1004451
	1100lm	60°	19	1004452



	985lm	24°	16	1004150
2700K	985lm	36°	16	1004151
	980lm	60°	19	1004152
	1020lm	24°	13	1004158
3000K	1020lm	36°	13	1004159
	1020lm	60°	19	1004160
	1100lm	24°	16	1004166
4000K	1100lm	36°	16	1004167
	1100lm	60°	19	1004168



	985lm	24°	16	1004438
2700K	985lm	36°	16	1004439
	980lm	60°	19	1004440
	1020lm	24°	13	1004446
3000K	1020lm	36°	13	1004447
	1020lm	60°	19	1004448
	1100lm	24°	16	1004454
4000K	1100lm	36°	16	1004455
	1100lm	60°	19	1004456



SLV NUMINOS® M



PD

Produktangaben:

220-240V ~50/60Hz | 500mA

Systemleistung: 20W

Material: Aluminium / Polycarbonat (PC)

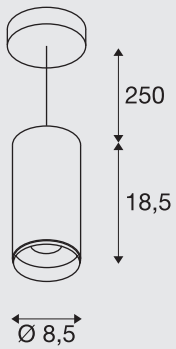

Hinweis:

Zierring auch in Weiß erhältlich

Zierring M

■ weiß

Art. Nr. 1006168



■ schwarz

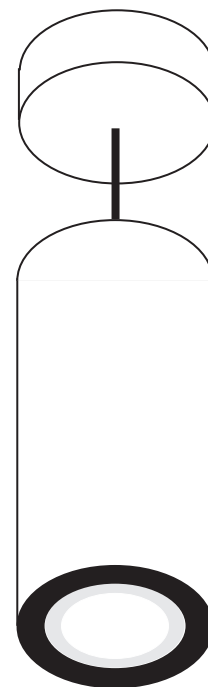

□ weiß



ART. NR.



	1925lm	24°	16	1004242
2700K	1935lm	36°	16	1004243
	1885lm	60°	22	1004244
	1955lm	24°	16	1004250
3000K	1970lm	36°	13	1004251
	1880lm	60°	22	1004252
	2125lm	24°	19	1004258
4000K	2120lm	36°	16	1004259
	2060lm	60°	25	1004260



	1925lm	24°	16	1004530
2700K	1935lm	36°	16	1004531
	1885lm	60°	22	1004532
	1955lm	24°	16	1004538
3000K	1970lm	36°	13	1004539
	1880lm	60°	22	1004540
	2125lm	24°	19	1004546
4000K	2120lm	36°	16	1004547
	2060lm	60°	25	1004548



	1925lm	24°	16	1004246
2700K	1935lm	36°	16	1004247
	1885lm	60°	22	1004248
	1955lm	24°	16	1004254
3000K	1970lm	36°	13	1004255
	1880lm	60°	22	1004256
	2125lm	24°	19	1004262
4000K	2120lm	36°	16	1004263
	2060lm	60°	25	1004264



	1925lm	24°	16	1004534
2700K	1935lm	36°	16	1004535
	1885lm	60°	22	1004536
	1955lm	24°	16	1004542
3000K	1970lm	36°	13	1004543
	1880lm	60°	22	1004544
	2125lm	24°	19	1004550
4000K	2120lm	36°	16	1004551
	2060lm	60°	25	1004552



SLV NUMINOS® L



PD

Produktangaben:

220-240V ~50/60Hz| 700mA

Systemleistung: 28W

Material: Aluminium / Polycarbonat (PC)

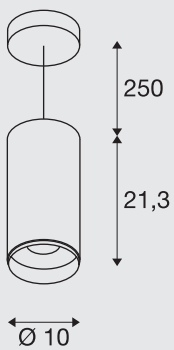
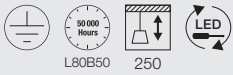

Hinweis:

Zierring auch in Weiß erhältlich

Zierring L

■ weiß

Art. Nr. 1006169



■ schwarz

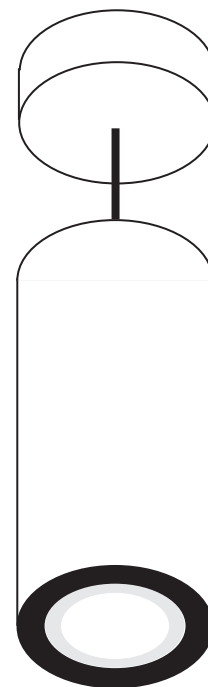

□ weiß



ART. NR.



	2440lm	24°	19	1004338
2700K	2400lm	36°	19	1004339
	2475lm	60°	22	1004340
	2430lm	24°	13	1004346
3000K	2340lm	36°	13	1004347
	2400lm	60°	22	1004348
	2675lm	24°	19	1004354
4000K	2620lm	36°	19	1004355
	2715lm	60°	22	1004356



	2440lm	24°	19	1004626
2700K	2400lm	36°	19	1004627
	2475lm	60°	22	1004628
	2430lm	24°	13	1004634
3000K	2340lm	36°	13	1004635
	2400lm	60°	22	1004636
	2675lm	24°	19	1004642
4000K	2620lm	36°	19	1004643
	2715lm	60°	22	1004644



	2440lm	24°	19	1004342
2700K	2400lm	36°	19	1004343
	2475lm	60°	22	1004344
	2430lm	24°	13	1004350
3000K	2340lm	36°	13	1004351
	2400lm	60°	22	1004352
	2675lm	24°	19	1004358
4000K	2620lm	36°	19	1004359
	2715lm	60°	22	1004360



	2440lm	24°	19	1004630
2700K	2400lm	36°	19	1004631
	2475lm	60°	22	1004632
	2430lm	24°	13	1004638
3000K	2340lm	36°	13	1004639
	2400lm	60°	22	1004640
	2675lm	24°	19	1004646
4000K	2620lm	36°	19	1004647
	2715lm	60°	22	1004648



SLV NUMINOS® XL



PD

Produktangaben:

220-240V ~50/60Hz | 900mA

Systemleistung: 36W

Material: Aluminium / Polycarbonat (PC)

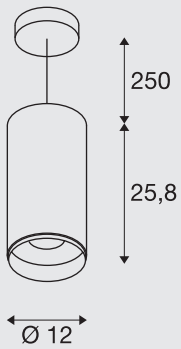
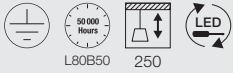

Hinweis:

Zierring auch in Weiß erhältlich

Zierring XL

■ weiß

Art. Nr. 1006170



■ schwarz

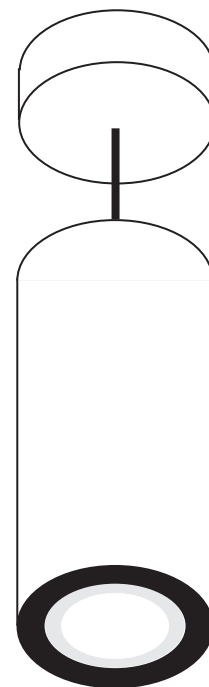

□ weiß



ART. NR.



	3290lm	24°	19	1005705
2700K	3250lm	36°	19	1005706
	2980lm	60°	25	1005707
	3530lm	24°	19	1005711
3000K	3490lm	36°	19	1005712
	3210lm	60°	25	1005713
	3800lm	24°	19	1005717
4000K	3760lm	36°	19	1005718
	3460lm	60°	25	1005719



	3290lm	24°	19	1005777
2700K	3250lm	36°	19	1005778
	2980lm	60°	25	1005779
	3530lm	24°	19	1005783
3000K	3490lm	36°	19	1005784
	3210lm	60°	25	1005785
	3800lm	24°	19	1005789
4000K	3760lm	36°	19	1005790
	3460lm	60°	25	1005791



	3290lm	24°	19	1005708
2700K	3250lm	36°	19	1005709
	2980lm	60°	25	1005710
	3530lm	24°	19	1005714
3000K	3490lm	36°	19	1005715
	3210lm	60°	25	1005716
	3800lm	24°	19	1005720
4000K	3760lm	36°	19	1005721
	3460lm	60°	25	1005722



	3290lm	24°	19	1005780
2700K	3250lm	36°	19	1005781
	2980lm	60°	25	1005782
	3530lm	24°	19	1005786
3000K	3490lm	36°	19	1005787
	3210lm	60°	25	1005788
	3800lm	24°	19	1005792
4000K	3760lm	36°	19	1005793
	3460lm	60°	25	1005794





Wer ein Projekt mit SLV NUMINOS® Downlights oder Spots verwirklicht hat, kann sich beruhigt zurücklehnen. Denn durch die Qualität der verbauten LED-Module und Treiber sind Langlebigkeit und Lichtqualität garantiert. Wann starten Sie Ihr Projekt mit dem SLV NUMINOS® Leuchtensystem?

SYMBOLERKLÄRUNG



Dimmbar mit ...

- C = Phasenabschnittsdimmer
- Dali = Dali Bussystem

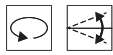

Dreh- und Schwenkbarkeit in Grad:

- Drehbereich
- Schwenkbereich



Der Halbstreuwinkel

beschreibt den Ausstrahlungswinkel in Grad. Je kleiner der Winkel desto stärker wird das Licht gebündelt.



Netzkabellänge in cm



Pendelkabellänge in cm



Leuchten mit eingebauten LEDs

Die Lichtquelle dieser Leuchte darf nur vom Hersteller oder einem von ihm beauftragten Servicetechniker ersetzt werden.



Der Lichtstromerhalt

Beschreibt um wie viel der Lichtstrom einer LED im angegebenen Zeitraum abnimmt.



UGR = Unified Glare Rating

Je niedriger der UGR-Wert, desto geringer die psychologische Blendung.



Farbtemperatur



Lumen



Steuerung



Schutzklassen

- Schutzklasse I / Schutzleiter
- Schutzklasse II / Schutz durch doppelte oder verstärkte Isolierung
- Schutzklasse III / Schutz durch Kleinspannung



Der **IK-Stoßfestigkeitsgrad** ist ein Maß für die Widerstandsfähigkeit von Gehäusen elektrischer Betriebsmittel gegen mechanische Beanspruchung, insbesondere Stoßbeanspruchung.



IP-Schutzart

Gibt die Eignung elektrischer Betriebsmittel für verschiedene Umgebungsbedingungen an.



Unabhängiger Konverter

(Betriebsgerät auch zur Verwendung außerhalb von Leuchten)



Kurzschlussfestes Sicherheitsbetriebsgerät



- Einsatz **ausschließlich** für Innenräume
- **Ungeeignet** für die Anwendung in Innenräumen



Kennzeichnet Produkte mit **eingebauten LEDs**



Kennzeichnet Leuchten aus einer **Leuchtenfamilie**



Ihren optionalen Treiber (On/Off, Phasendimmung, DALI) und passende Diffusoren können Sie über die **Farbkodierung** ganz einfach hinzufügen.

Bitte beachten Sie:

Ein großer Teil der in diesem Katalog vorgestellten Produkte ist durch Warenzeichen, Geschmacksmuster, Gebrauchsmuster oder Patente geschützt. Ein Verstoß gegen diese Schutzrechte oder eine Verwendung von Text- und Layoutgestaltung sowie urheberrechtlich geschützten Bildern ohne unsere Genehmigung wird gerichtlich verfolgt. Die in diesem Katalog enthaltenen Abbildungen und Angaben dienen nur der Veranschaulichung und sind unverbindlich in Farbe, Form, Ausführung und technischen Daten. Bei sämtlichen Produktbeschreibungen/-angaben bleiben Änderungen und Irrtümer daher vorbehalten.

Alle Produkte unseres Sortiments unterliegen einer strengen Qualitätssicherung und erfüllen die allgemein gültigen Normen. Dieser Katalog beinhaltet ein allgemeines Sortiment und ist nicht landesspezifisch ausgelegt. Etwaige Abweichungen von landesspezifischen Vorgaben sind vor der Bestellung zu klären. SLV haftet nicht für gegebenenfalls abweichende technische Normen. Alle Gewichts- und Längenangaben sind in kg bzw. in cm angegeben, sofern nicht anders bezeichnet. Technische Änderungen vorbehalten!

Die Präsentation unserer Leuchten mit realistischen und beispielhaften Anwendungsfotos wird ermöglicht durch das freundliche Entgegenkommen und die Zustimmung der Eigentümer oder Gestalter der jeweils vordergründig in den Bildern zu sehenden Umgebungen. All jenen, die durch ihr Einverständnis zur Entstehung und Verwendung unserer Fotos beigetragen haben, sei an dieser Stelle nochmals herzlich gedankt!

Unser gesamtes Sortiment finden Sie auf unserer Internetseite KS-Licht.ch und im aktuellen Katalog **BIG WHITE® 2022**.

Bildnachweise
SLV GmbH
www.gettyimages.de



KS Licht- u. Elektrotechnik GmbH
Manderscheidstr. 8c
45141 Essen

Tel.: +49 (0)201-89924-0
Fax: +49 (0)201-89924-124

Kostenlose Bestell-Hotline:
0800-KSLICHT (0800-5754248)

Internet: www.KS-Germany.com
Email: Verkauf@KS-Germany.com